



For additional information or copies of your IntelliSpray ST1™ manual, please visit us online at:

<https://www.binks.com>

Or use this QR code with your mobile device:



Obey local or municipal regulations for product recycling and disposal.

## ABOUT THIS MANUAL

### PURPOSE

The purpose of this manual is to help you get the most value from your IntelliSpray™ ST1™ Foam Spray Gun. It can help you to determine how to install, operate, maintain, and repair your equipment. It provides information and procedures for routine maintenance and servicing and offers diagnostic and repair procedures to follow when trouble occurs.

### CONTENTS

This manual is divided into Chapters, each of which is divided into consecutively numbered Sections.

Chapters will contain text, images, tables, or a combination of them.

Pages with images will have paragraphs and sentences with callout numbers that refer to their respective images, steps, and parts.

Procedures, once described in the text, are not normally repeated. When it is necessary to refer to another Chapter or Section, the reference will be given as Chapter and Section number. Cross references given without the use of the word "Chapter" apply to Sections or paragraphs in the current Chapter.

### WHO SHOULD USE THIS GUIDE

This guide is intended for users with different levels of knowledge and experience with this system:

**Installers:** The person(s) who will locate and install this equipment.

**Users:** The person(s) who will learn how to operate this equipment.

**Servicers:** The person(s) who will service and maintain this equipment.

This guide assumes all persons who will install, use, operate, and service this equipment have some knowledge of the product and its operating system.

### MANUAL DISCLAIMER

All current and applicable certifications shown in this manual confirm Binks' adherence to the strict standards met to obtain the required regulatory compliances.

This manual was prepared with the most accurate information current at the time of publishing. Binks does not accept responsibility for errors in, or omissions from, the information contained herein.

Please get in touch with your distributor or Binks Customer Service for additional service information and assistance.

**ST1 RELATED MANUALS & PUBLICATIONS**

Part Number	Description
347492	IntelliSpray™ IS30 User Manual
341162	IntelliSpray™ IS40 User Manual
341164	Quickheat™ Hose User Manual

## 02. CONTENTS

<b>03 SAFETY</b>	<b>3</b>
03.1 SAFETY PRECAUTIONS .....	3
03.2 ADDITIONAL SAFETY INFORMATION .....	10
<b>04. DECLARATIONS</b>	<b>11</b>
04.1 EU DECLARATION OF CONFORMITY .....	11
04.2 UKCA DECLARATION OF CONFORMITY .....	12
<b>05. IMPORTANT ISOCYANATE INFORMATION</b>	<b>13</b>
05.1 GENERAL HANDLING GUIDELINES .....	13
05.2 MATERIAL SELF IGNITION .....	14
05.3 KEEP COMPONENTS A & B SEPARATE .....	14
05.4 EXPOSURE TO MOISTURE .....	14
05.5 FOAM RESINS W/245 FA BLOWING AGENTS .....	14
05.6 CHANGING MATERIALS .....	14
05.7 ELECTRICAL GROUND .....	14
<b>06. ST1™ SPRAY FOAM GUN OVERVIEW</b>	<b>15</b>
06.1 TECHNICAL SPECIFICATIONS .....	15
06.2 AIR FLOW RATE DATA - SCFM (SLPM) .....	15
06.3 FLOW RATES AND PATTERN SIZES .....	16
06.4 ST1 SPRAY GUN COMPONENTS .....	17
06.5 PISTON SAFETY STOP/LOCK .....	18
06.6 LOSS OF AIR PRESSURE .....	18
06.7 GETTING STARTED, SET-UP .....	19
06.8 PRESSURE RELIEF AND SHUT DOWN .....	21
06.9 REPOSITION HOSES (OPTIONAL) .....	22
<b>07. MAINTENANCE</b>	<b>23</b>
07.1 TOOLS .....	23
07.2 MIX TIP MAINTENANCE .....	24
07.2.1 CLEANING MIX TIP IN PLACE .....	24
07.2.2 REMOVE MIX TIP FOR CLEANING .....	24
07.2.3 CHANGING MIX TIP .....	24
07.3 MIX CHAMBER MAINTENANCE .....	25
07.4 GUN FLUSHING PROCEDURE .....	26
07.5 HEAD ASSEMBLY SERVICING .....	27
07.5.1 SIDE SEAL SERVICING .....	27
07.5.2 CHECK VALVE SERVICING .....	27
07.6 FLUID MANIFOLD ASSEMBLY SERVICING .....	28
07.7 SAFETY STOP ASSEMBLY SERVICING .....	29
07.8 HANDLE ASSEMBLY SERVICE .....	30
07.8.1 HANDLE AND HEAD DRILL BIT KIT (336439) .....	31

<b>07. MAINTENANCE</b>	<b>23</b>
07.9 PISTON AND AIR VALVE ASSEMBLY SERVICE .....	32
07.10 STRAP INSTALLATION .....	33
07.11 SPRAY FOAM GUN COMPONENTS .....	35
07.11.1 ST1™ SPRAY GUN COMPONENTS .....	36
07.12 MIX CHAMBERS AND MIX TIPS .....	38
07.12.1 STANDARD MIX CHAMBER (18) / MIX TIP (19) COMBINATIONS (INCL. DRILL BIT).....	38
07.12.2 INDIVIDUAL MIX CHAMBERS (INCL. DRILL BIT).....	38
07.12.3 INDIVIDUAL MIX TIPS (INCL. DRILL BIT).....	38
07.12.4 EXTENSION MIX TIPS (INCL. DRILL BIT) .....	39
07.12.5 HARDENED MIX TIPS (INCL. DRILL BIT) .....	39
07.12.6 POUR TIPS (INCL. DRILL BIT) .....	39
07.12.7 VARIABLE RATIO MIX CHAMBER (18) / MIX TIP (19) KIT (INCL. DRILL BIT)* .....	39
07.13 SPARE PARTS AND ACCESSORIES.....	40
07.13.1 O-RING QUANTITY PACKS .....	40
07.13.2 WETTED PARTS O-RING KIT 336416.....	40
07.13.3 COMPLETE O-RING KIT 336421 .....	40
07.13.4 MIX CHAMBER CLEAN-OUT DRILL BITS.....	41
07.13.5 MIX TIP CLEAN-OUT DRILL BITS.....	41
07.13.6 ACCESSORIES, SPARE KITS, AND TOOLS.....	41
<b>08. TROUBLESHOOTING</b>	<b>43</b>
<b>09. WARRANTY POLICY</b>	<b>45</b>

## 03 SAFETY

### 03.1 SAFETY PRECAUTIONS

Before the operation, maintenance, or servicing of this Binks system; fully read and understand all technical and safety literature for your product. This manual contains information that is important for you to know and understand.

#### **This information relates to USER SAFETY and the PREVENTION OF EQUIPMENT PROBLEMS.**

To help you understand this information, we use recognizable ANSI Z535 and ISO warning boxes and symbols throughout this manual. Please obey these safety sections.

#### **⚠ DANGER**

**DANGER!** Indicates a hazardous situation that, if not avoided, will result in death or severe injury.

#### **⚠ WARNING**

**WARNING!** Indicates a hazardous situation that, if not avoided, could result in death or severe injury.

#### **⚠ CAUTION**

**Caution!** Indicates a hazardous situation that, if not avoided, could result in minor or moderate injury, or equipment damage.

#### **NOTICE**

**Notice:** Indicates information considered important but not hazard related.

#### **SAFETY**

**Safety:** Indicates a type of safety instruction, or a separate panel on a safety placard, where specific safety-related instructions or procedures are described.

Careful study and continued use of this manual will provide a better understanding of the equipment functions and procedures.

This understanding will result in improved operation, efficiency, and longer, trouble-free service with faster and easier troubleshooting. If you need the necessary safety literature for your specific system, contact your local Binks representative or Binks directly.

#### **NOTICE**

This manual lists standard specifications and service procedures. Differences can occur between this literature and your equipment.

Differences in local or municipal codes, manufacturer or plant requirements, material delivery requirements, and more can make variations unpreventable. To find these differences, compare this manual to your system installation drawings and other applicable Binks equipment manuals.

#### **⚠ WARNING**

The user **MUST** read and be familiar with the Safety Section in this manual and the safety literature therein identified.

Only trained personnel can operate this equipment.



All personnel who operate, clean, or maintain this equipment **MUST** fully read and understand this manual! To operate and service the equipment, follow all **WARNINGS** and safety requirements.

The user must be aware of and adhere to **ALL** local building and fire codes and ordinances, as well as NFPA 33 AND EN 16985 SAFETY STANDARDS, LATEST EDITION, or applicable country safety standards, before the installation, operation, or servicing of this equipment.



#### **⚠ WARNING**





The hazards shown on the pages that follow can occur during the normal use of this Binks equipment, but not all listed hazards will be applicable to your product model or equipment.

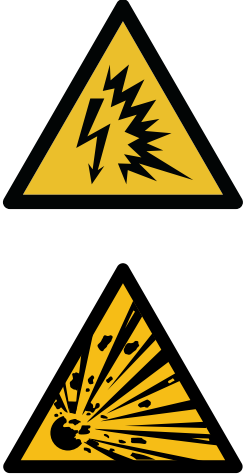

**Repairs may only be performed by personnel authorized by Binks.**





<p><b>AREAS</b> Indicate possible hazard occurrences.</p>	<p><b>HAZARDS</b> Indicate possible hazards.</p>	<p><b>SAFEGUARDS</b> Prevention of possible hazards.</p>
<p><b>Spray Areas</b></p>  	<p><b>Fire Hazards</b></p> <p>Improper or unsatisfactory operation and maintenance procedures will cause a fire hazard.</p> <p>If the safety interlocks are disabled during operation, protection against accidental arcing is shut off and can cause a fire or explosion.</p> <p>Frequent Power Supply or Controller shutdown identifies a problem in the system. For this occurrence, a correction will be necessary</p>	<p>Fire extinguishing equipment must be present in the spray area. Periodically run a test to make sure the equipment stays usable.</p> <p>Keep spray areas clean to prevent the build-up of combustible residues.</p> <p>Do not smoke in the spray area.</p> <p>The high voltage supplied to the atomizer must be turned off before the equipment is cleaned, flushed or maintained.</p> <p>Spray booth ventilation must be kept at the rates as set by NFPA-33, OSHA, country, local, and municipal codes.</p> <p>If flammable or combustible solvents are used to clean the equipment, ventilate the area.</p> <p>Prevent electrostatic arcing. Maintain spark-safe work distance between the parts that get coated and the applicator. A span of one inch for every 10KV of the output voltage is necessary.</p> <p>Do an equipment test only in areas free of combustible material. The test may necessitate the high voltage to be on, but only as instructed.</p> <p>Non-factory replacement parts or unauthorized equipment modifications can cause a fire or injury.</p> <p>The key switch bypass is used only during setup operation.</p> <p>Do no production work with disabled safety interlocks.</p> <p>Set up and operate the paint procedure and equipment under NFPA-33, NEC, OSHA, local, municipal, country, and European Health and Safety Norms.</p>



<p><b>AREAS</b> Indicate possible hazard occurrences.</p>	<p><b>HAZARDS</b> Indicate possible hazards.</p>	<p><b>SAFEGUARDS</b> Prevention of possible hazards.</p>
<p><b>Spray Areas</b></p> 	<p><b>Explosion Hazard</b></p> <p>Improper or unsatisfactory operation and maintenance procedures will cause a fire or explosion hazard.</p> <p>If the safety interlocks are disabled during operation, protection against accidental arcing is shut off and can cause a fire or explosion.</p> <p>Frequent Power Supply or Controller shutdown identifies a problem in the system. For this occurrence, a correction will be necessary.</p>	<p>Prevent electrostatic arcing. Maintain spark-safe work distance between the parts that get coated and the applicator. A span of one inch for every 10KV of output voltage is necessary.</p> <p>Unless specifically approved for use in hazardous locations, put all electrical equipment outside of Class I or II, Division 1 or 2 hazardous areas in accordance with NFPA-33, or outside of Zone 2 or Zone 22 in accordance with EN standards.</p> <p>If equipped, set the current overload sensitivity as described in the related section of the equipment manual. If incorrectly set, the current overload sensitivity for protection against accidental arcing is turned off and can cause a fire or explosion.</p> <p>Frequent power supply shutdown indicates a problem in the system, which requires correction.</p> <p>Always turn off the control panel power before the system is flushed, cleaned, or servicing the spray system equipment. Make sure no objects are within the spark-safe work distance before the high voltage is turned on.</p> <p>The control panel must interlock with the ventilation system and conveyor in accordance with NFPA-33, EN 50176.</p> <p>Fire extinguishing equipment must be present in the spray area. Periodically run a test to make sure the equipment stays usable. Do an equipment test only in areas free of combustible material.</p>
<p><b>General Use and Maintenance</b></p> 	<p>Improper or unsatisfactory operation and maintenance procedures will cause a fire hazard.</p> <p>Personnel must be correctly trained in the operation and maintenance of this equipment.</p>	<p>Train all personnel in accordance with the requirements of NFPA-33, EN 60079-0.</p> <p>Before equipment operation, personnel must read and understand these instructions and safety precautions.</p> <p>Obey appropriate local, municipal, state, and national codes governing ventilation, fire protection, operation maintenance, and housekeeping.</p> <p>Reference OSHA, NFPA-33, EN Norms, and your insurance company requirements.</p>

<p><b>AREAS</b> Indicate possible hazard occurrences.</p>	<p><b>HAZARDS</b> Indicate possible hazards.</p>	<p><b>SAFEGUARDS</b> Prevention of possible hazards.</p>
<p><b>Spray Area High Voltage Equipment</b></p>    	<p><b>Electrical Discharge</b></p> <p>This equipment contains a high-voltage device that can cause an electrostatic induction on ungrounded objects. This electrical charge is capable of igniting coating materials.</p> <p>Insufficient ground will cause a spark hazard. A spark can ignite many coating materials and cause a fire or explosion.</p>	<p>Operators in the spray area and the parts to be sprayed must be sufficiently grounded.</p> <p>All conductive objects inside the spray area must be grounded.</p> <p>Hold the parts that get sprayed on conveyors or hangers that are correctly grounded. The resistance between the parts and the earth-ground must not be more than 1 MΩ. Refer to: NFPA-33.</p> <p>Before the equipment is operated, ground all operators. They cannot wear rubber-soled insulated shoes. Wear ground straps on wrists or legs for sufficient ground contact.</p> <p>Operators must not wear or carry ungrounded metal objects.</p> <p>When used, operators must make complete contact with the applicator handle and electrostatic gun. Use conductive gloves or gloves with the palm section cut out.</p> <p>Operators must wear grounded footwear.</p> <p><b>NOTE: REFER TO NFPA-33 OR SPECIFIC COUNTRY SAFETY CODES FOR GUIDANCE TO CORRECTLY GROUND THE OPERATOR.</b></p> <p>Except for objects needed for the high-voltage process, all electrically conductive objects in the spray area are to be grounded. Supply a grounded conductive floor in the spray area.</p> <p>Always turn off the applicator voltage before the system is flushed, cleaned, or when servicing the spray system equipment.</p> <p>Unless specifically approved for use in hazardous locations, put all electrical equipment outside of Class I or II, Division 1 or 2 hazardous areas in accordance with NFPA-33, or outside of Zone 2 or Zone 22 in accordance with EN standards.</p> <p>Do not install an applicator into a fluid system if the solvent supply is ungrounded.</p> <p>Do not touch an energized applicator electrode.</p>

<p><b>AREAS</b> Indicate possible hazard occurrences.</p>	<p><b>HAZARDS</b> Indicate possible hazards.</p>	<p><b>SAFEGUARDS</b> Prevention of possible hazards.</p>
<p><b>Spray Areas</b></p> 	<p><b>Toxic Fluid or Fumes</b></p> <p>Toxic fluids or fumes can cause severe injury or death if splashed in the eyes or on the skin, or if inhaled or swallowed.</p>	<p>Read the Safety Data Sheet (SDS) for instructions to know and understand how to handle the specific hazards of the fluids used, and the effects of long-term exposure.</p> <p>During the spray, clean, or servicing of equipment, or when in the work area, keep the work area fully ventilated.</p> <p>Always wear personal protective equipment (PPE) when in the work area or during equipment operation. Refer to the Personal Protective Equipment warnings in this manual.</p> <p>Store hazardous fluid in approved containers and refer to local, municipal, state, and national codes governing the disposal of hazardous fluids.</p>
<p><b>Spray Area and Equipment Use</b></p> 	<p>High-pressure fluid sprayed from the gun, hose fittings, or ruptured/damaged components can pierce the skin.</p> <p>While this injury can appear as cut skin, this is a severe injury that can result in the amputation of the affected area.</p>	<p>Do not point or operate the spray gun at the body part of a person.</p> <p>Do not put your hand or fingers over the gun fluid nozzle or fittings in the hose or Proportioner.</p> <p>Do not try to stop or deflect leaks with your hand, glove, body, or shop rag.</p> <p>Do not “blowback” fluid, as the equipment is not an air spray system.</p> <p>Relieve pressure in the supply hoses, Proportioner, and QuickHeat™ hose before the equipment is inspected, cleaned, or serviced.</p> <p>Use the lowest possible pressure to recirculate, purge, or troubleshoot the equipment.</p> <p>Examine the hoses, couplings, and fittings every day. Service or immediately replace parts that leak, are worn, or are damaged. Replace high-pressure hose sections. They cannot be recoupled or serviced.</p>

<p><b>AREAS</b> Indicate possible hazard occurrences.</p>	<p><b>HAZARDS</b> Indicate possible hazards.</p>	<p><b>SAFEGUARDS</b> Prevention of possible hazards.</p>
<p><b>Equipment and Fluids</b></p> 	<p><b>Skin and Clothing Burns</b></p> <p>Equipment surfaces and fluids can become very hot during operation.</p>	<p>Do not touch hot fluid or equipment during operation.</p> <p>Do not let clothing touch the equipment during operation or immediately after the equipment is stopped.</p> <p>Let the equipment fully cool before the examination or servicing of the component.</p>
<p><b>Pressurized Aluminum Parts</b></p>    	<p>The use of certain solvents and chemicals can cause equipment damage and severe personal injury.</p>	<p>Do not use 1,1,1-trichloroethane, methylene chloride or other halogenated hydrocarbon solvents or fluids that contain such solvents.</p> <p>These solvents can cause a severe chemical reaction and equipment rupture that results in equipment and property damage, serious bodily injury, or death.</p>

<p><b>AREAS</b> Indicate possible hazard occurrences.</p>	<p><b>HAZARDS</b> Indicate possible hazards.</p>	<p><b>SAFEGUARDS</b> Prevention of possible hazards.</p>
<p><b>Spray Areas</b></p> 	<p><b>Do Not Touch</b></p> <p>The effect of paint flow rates and formulations on the quality of atomization can cause the turbines to rotate at high speeds.</p>	<p>Do not use a rag or gloved hand against the bell edge to stop or slow down a bell during rotation.</p> <p>Do not try to clean the bell edge during rotation.</p>

**⚠ CAUTION**

Only operate the equipment after you have read this section.

**03.2 ADDITIONAL SAFETY INFORMATION**

The IntelliSpray has an emergency stop (E-Stop) pushbutton on the main operator panel. During an emergency, all operations for the IntelliSpray will halt when the E-Stop is engaged. The operator must disengage the E-Stop and reset the system to recover from this state.

Observe all local or municipal safety measures and wear approved protective equipment when servicing this equipment. Clean all spilled chemicals and materials and do all work in a clean and organized environment to prevent personal injury and equipment damage.

**⚠ DANGER**

To prevent injury or electrocution while the system is under power, do not contact, disconnect, or manipulate electrical connections or devices. The main disconnect on the right side of the controller can be locked out. Follow the proper Lockout-Tagout (LOTO) procedures for internal controller electrical work.

Only qualified electrical personnel can perform the work if diagnosis and troubleshooting are not possible during working conditions.

**⚠ WARNING**

To prevent possible chemical spillage when personnel are not on site, air and fluid supplies for the equipment must be disabled when the equipment idles for an extended period, such as an end-of-day shutdown.

**NOTICE**

During the initial commission of the equipment and at periodic times throughout equipment life, visually examine all fluid fittings for leaks.

Periodically, it is necessary to visually examine all pieces of this equipment for signs of noticeable degradation due to chemicals or other conditions in the equipment's environment.



**SAFETY**

Obey local or municipal regulations that require installed fire suppression for equipment operation.

If the operation of this equipment, sensors, switches, or other ancillary equipment occurs in the presence of flammable gases and vapors, connect this equipment through intrinsic-safe or Zener barriers. Classify them as a 'simple apparatus' or approve them for use in these areas.

04. DECLARATIONS

04.1 EU DECLARATION OF CONFORMITY

<b>Product Description / Object of Declaration:</b>	Applicator ST-1	
<b>This Product is designed for use with:</b>	Fast Set Polyurethane Foams and Polyureas	
<b>Suitable for use in hazardous area:</b>		
<b>Protection Level:</b>	Not Applicable	
<b>Notified body details and role:</b>		
<b>This Declaration of Conformity / Incorporation is issued under the sole responsibility of the manufacturer:</b>	Binks US LLC. 3760 Victoria St N Shoreview, MN 55126. USA	
<b>Representative authorised to compile the technical file</b>	President @. Binks France SAS 5 Place Pierre Semard, 94130 Nogent sur Marne , Paris, France	
<b>EU Declaration of Conformity</b>		
<b>This Declaration of Conformity / Incorporation is issued under the sole responsibility of the manufacturer:</b>		
<p>Machinery Directive 2006/42/EC                  by complying with the following statutory documents and harmonised standards:                  EN ISO 12100:2010 Safety of Machinery - General Principles for Design</p>		
<p>Providing all conditions of safe use / installation stated within the product manuals have been complied with and also installed in accordance with any applicable local codes of practice.</p>		
Signed for and on behalf of Binks US LLC:		F. A. Sutter Executive President: Engineering and Operations, Shoreview, MN, 55126. USA
Document Part No. EN		

04.2 UKCA DECLARATION OF CONFORMITY

<b>Product Description / Object of Declaration:</b>	<b>Applicator ST-1</b>	
<b>This Product is designed for use with:</b>	<b>Fast Set Polyurethane Foams and Polyureas</b>	
<b>Suitable for use in hazardous area:</b>		
<b>Protection Level:</b>	<b>Not Applicable</b>	
<b>Notified body details and role:</b>		
<b>This Declaration of Conformity / Incorporation is issued under the sole responsibility of the manufacturer:</b>	<b>Binks US LLC. 3760 Victoria St N Shoreview, MN 55126. USA</b>	
<b>UKCA Declaration of Conformity</b>		<b>UK CA</b>
<b>This Declaration of Conformity / Incorporation is issued under the sole responsibility of the manufacturer:</b>		
<p>Machinery Directive 2006/42/EC                  by complying with the following statutory documents and harmonised standards:                  BS EN ISO 12100:2010 Safety of Machinery - General Principles for Design</p>		
<p>Providing all conditions of safe use / installation stated within the product manuals have been complied with and also installed in accordance with any applicable local codes of practice.</p>		
Signed for and on behalf of Binks US LLC:	 F. A. Sutter	Executive President: Engineering and Operations, Shoreview, MN, 55126. USA
Document Part No. EN		



## 05. IMPORTANT ISOCYANATE INFORMATION

### 05.1 GENERAL HANDLING GUIDELINES

Isocyanates (ISO) are catalysts used in two component materials.

Fluids with isocyanates that are sprayed or dispensed creates potentially harmful mists, vapors, and atomized particulates. Workers exposed to isocyanates can develop a range of short and long-term health problems.

**Read and understand the fluid manufacturer's warnings and Safety Data Sheet (SDS) for specific hazards and precautions related to isocyanates.**

- Use of isocyanates involves potentially hazardous procedures. Do not spray with this equipment unless you are trained, qualified, and have read and understood the information in this manual and in the fluid manufacturer's application instructions and SDS.
- Use of incorrectly maintained or adjusted equipment may result in unsatisfactory cured material which can off-gas and make offensive odors. Refer to the instruction in the manual to correctly maintain and operate the equipment.
- To prevent inhalation of isocyanate mists, vapors and atomized particulates, everyone in the work area must wear applicable respiratory protection. Always wear a correctly fitted respirator that includes a supplied-air respirator. Refer to the instructions in the fluid manufacturer's SDS for correct work area airflow.
- Avoid all skin contact with isocyanates. Everyone in the work area must wear chemically impermeable gloves, protective clothing, and foot cover recommended by the fluid manufacturer and local regulatory authorities. Follow all fluid manufacturer recommendations, to include the discard of contaminated clothing. Do not eat or drink after equipment use until hands and face have been washed.
- Hazard from exposure to isocyanates continues after spray use. Anyone without correct personal protective equipment must stay out of the work area during and after the application, and for the time period specified by the fluid manufacturer. This time period is usually a minimum of 24 hours.
- Warn others who may enter work area of hazard from exposure to isocyanates. Follow the recommendations of the fluid manufacturer and local regulatory authority.
- It is recommended to post a sign outside the work as the one shown below:



## 05.2 MATERIAL SELF IGNITION

Some materials may become self-igniting if applied too thick. Read material manufacturer's warnings and Safety Data Sheet

## 05.3 KEEP COMPONENTS A & B SEPARATE

Prevent cross contamination of A and B materials. Cured material in fluid lines and passages can cause serious personal injury or equipment damage.

Never interchange the wetted parts of components A and B.

Never use solvent on one side that is contaminated with fluid from the other side.

## 05.4 EXPOSURE TO MOISTURE

ISO will start to cure and form small, hard, abrasive crystals when exposed to moisture and humidity.

These crystals become suspended in the fluid and can cause equipment damage. Over time, a film will form on the surface and the ISO will get thicker with increased viscosity.

### NOTICE

ISO that has started to cure will reduce the life and performance of all wetted parts.

Take the following steps to prevent damage to spray gun components due to cured ISO:

- A sealed container with a desiccant dryer in the vent, or a nitrogen atmosphere in the empty head space of the container must be used.
- ISO must not be stored in an open container.
- The ISO pump reservoir must be kept filled with applicable lubricant. The lubricant creates a barrier between the ISO and the atmosphere.
- Only ISO compatible moisture-proof hoses must be used.
- Reclaimed solvents, which may contain moisture, must not be used.
- Solvent containers must be closed when not in use.
- Assemble threaded parts only with the correct lubricant.

## 05.5 FOAM RESINS W/245 FA BLOWING AGENTS

Some materials may become self-igniting if applied too thick. Read material manufacturer's warnings and Safety Data Sheet (SDS).

## 05.6 CHANGING MATERIALS

Prevent equipment damage and downtime during material changes and flushes for service or storage.

- Flush equipment multiple times to make sure it is fully clean.
- The fluid strainers must be cleaned after all flushes. Speak with the material manufacturer for information on chemical compatibility.
- When there is a change between epoxies, urethanes, or polyureas, all wetted parts must be disassembled and cleaned, and the hoses changed.

## 05.7 ELECTRICAL GROUND

Examine the local electrical code and Proportioner manual for instructions on how to correctly ground the equipment.

Ground the spray gun through a connection to a Binks approved grounded fluid supply hose.

## 06. ST1™ SPRAY FOAM GUN OVERVIEW

### 06.1 TECHNICAL SPECIFICATIONS

Maximum Fluid Pressure	2500 psi (172 bar) with Polymer Side Seals PN 336379
	3500 psi (242 bar) with Stainless Steel Side Seals PN 336381
Minimum Air Inlet Pressure	70 psi (0.48 MPa / 4.8 bar)
Maximum Air Inlet Pressure	130 psi (0.9 MPa / 9 bar)
Air Flow Range	See Fluid Flow Chart Section 06.3
Maximum Fluid Temperature	200°F (94° C)
Air Inlet Size	1/4" NPT Quick Disconnect Nipple
A Component (ISO) Inlet Size	5 JIC; 1/2-20 UNF
B Component (Resin) Inlet Size	6 JIC; 9/16-18 UNF
Sound Pressure	80.3 dB(A) D-02 Combination at 100 psi (6.9 bar)
Sound Power	88.7 dB(A) D-02 Combination at 100 psi (6.9 bar)
Dimensions	7.9 x 8.3 x 3.4 in (201 x 211 x 86mm)
Weight (with Manifold)	3.1 lb (1.4 kg)
Weight (without manifold)	2.4 lb (1.1 kg)
Wetted parts	Stainless Steel, Coated Aluminum, Plated Steel, Chemically Resistant Plastic, Chemically Resistant O-Rings

### 06.2 AIR FLOW RATE DATA - SCFM (SLPM)

Inlet Air Pressure (PSI)	Mix Chamber / Tip Combination					
	A-00	B-01	C-15	D-02	E-03	F-04
80.0	1.4 (42)	1.6 (45)	2.0 (56)	2.5 (70)	3.0 (86)	3.4 (96)
100.0	1.7 (48)	1.9 (55)	2.3 (66)	3.0 (85)	3.5 (100)	4.2 (118)

### 06.3 FLOW RATES AND PATTERN SIZES

The following chart shows typical flow rates (in GPM) for standard combinations of ST1 mix chambers and tips (E.g. A-00, B-01, C-15, D-02, E-03, F-04). Sprayers can use other combinations of chambers and tips to achieve intermediate results (e.g. D-15 will produce curved roughly between C-15 and D-02 results).

Output in LB/MIN is roughly equal to GPM X 10 (e.g. 2.5 GPM = 25 LB/MIN).

The dynamic pressure shown in the chart is measured at the end of the heated hose, not at the proportioner. Dynamic pressure at the proportioner would be higher by 1-2 psi/foot of hose (depending on flow rate and fluid viscosity).

Material used in this test was Carlisle SealTite Pro Closed Cell sprayed at 120°F on both A and B sides. Actual output is highly dependent on fluid viscosity.

The table shows typical pattern sizes for various tips at a distance of 24" from the substrate surface.

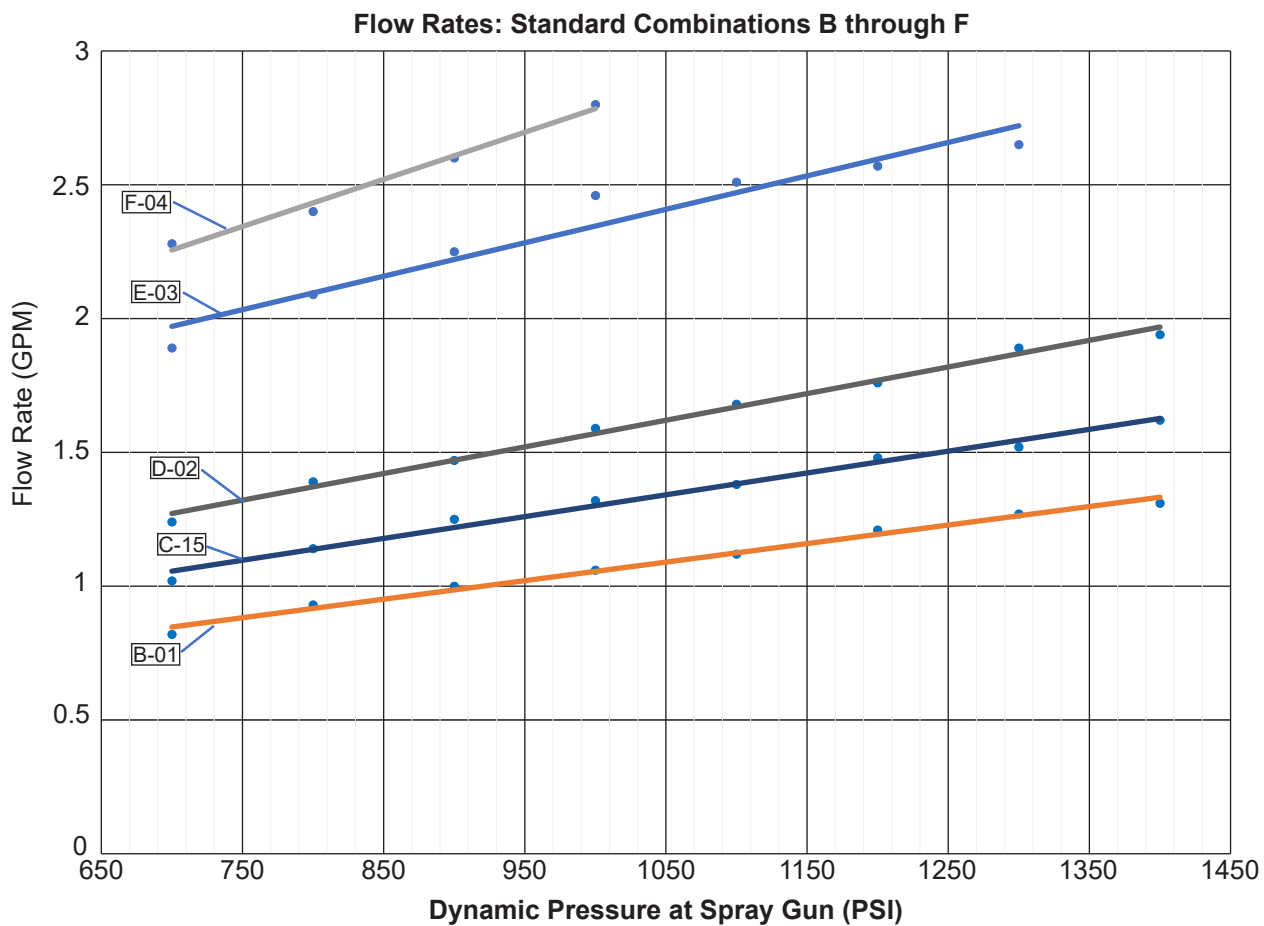

PATTERN WIDTH @ 24" FROM SUBSTRATE	
MIX TIP	WIDTH (IN)
01	11-12
15	12-13
02	13-14
03	15
04	17

06.4 ST1 SPRAY GUN COMPONENTS

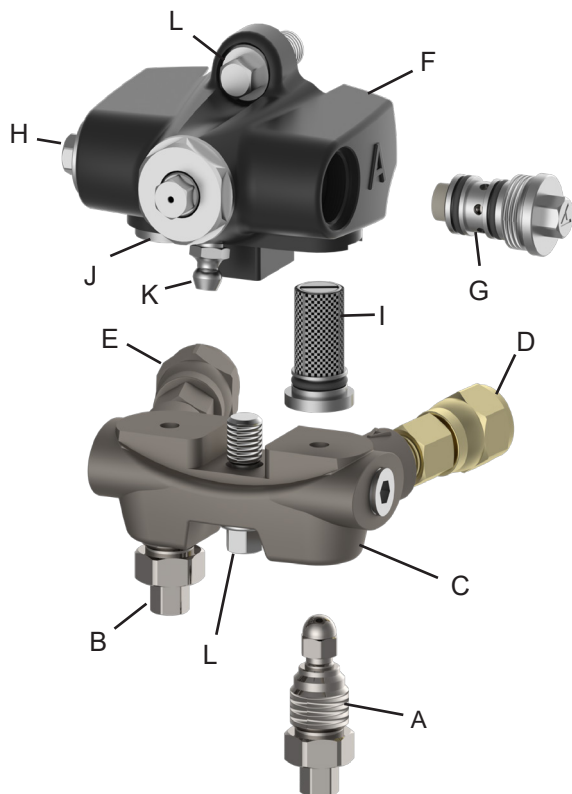
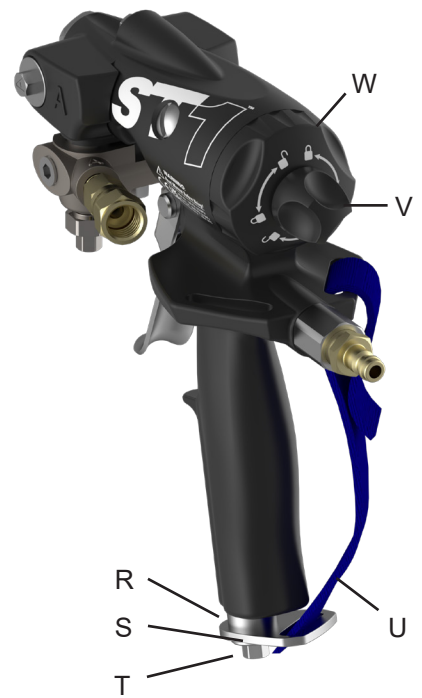
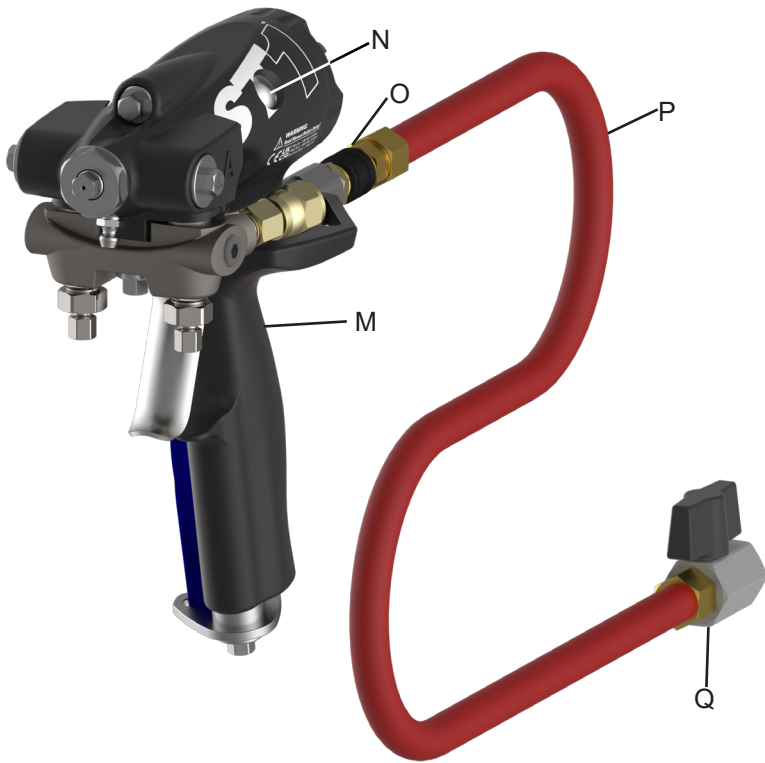

A	A-SIDE SHUT OFF VALVE
B	B-SIDE SHUT OFF VALVE
C	FLUID MANIFOLD
D	A-SIDE FLUID INLET SWIVEL
E	B-SIDE FLUID INLET SWIVEL
F	SPRAY GUN HEAD
G	A-SIDE SIDE SEAL ASSEMBLY
H	B-SIDE SIDE SEAL ASSEMBLY
I	A-SIDE CHECK VALVE
J	B-SIDE CHECK VALVE
K	GREASE FITTING
L	MANIFOLD SCREW
M	GUN HANDLE
N	CHECK VALVE (AIR)
O	QUICK DISCONNECT COUPLER
P	AIR HOSE (18 IN)
Q	BALL VALVE (AIR)
R	SPACE
S	STRAP CLIP
T	STRAP STUD
U	STRAP
V	SAFETY STOP KNOB
W	END CAP

## 06.5 PISTON SAFETY STOP/LOCK

**⚠ WARNING**

The spray gun is equipped with a safety stop/lock. Always engage safety stop/lock when not spraying to prevent accidental triggering

**To engage piston safety lock:** push knob in and turn clockwise. If engaged, spray gun will not actuate.



**To disengage piston safety lock:** push knob in and turn counterclockwise until it pops out. There will be a gap between the knob and the spray gun body.



## 06.6 LOSS OF AIR PRESSURE

**⚠ WARNING**

In the event of loss of air pressure, spray gun will continue to spray. To shut off spray gun, engage the safety stop/lock and/or close both shut off valves

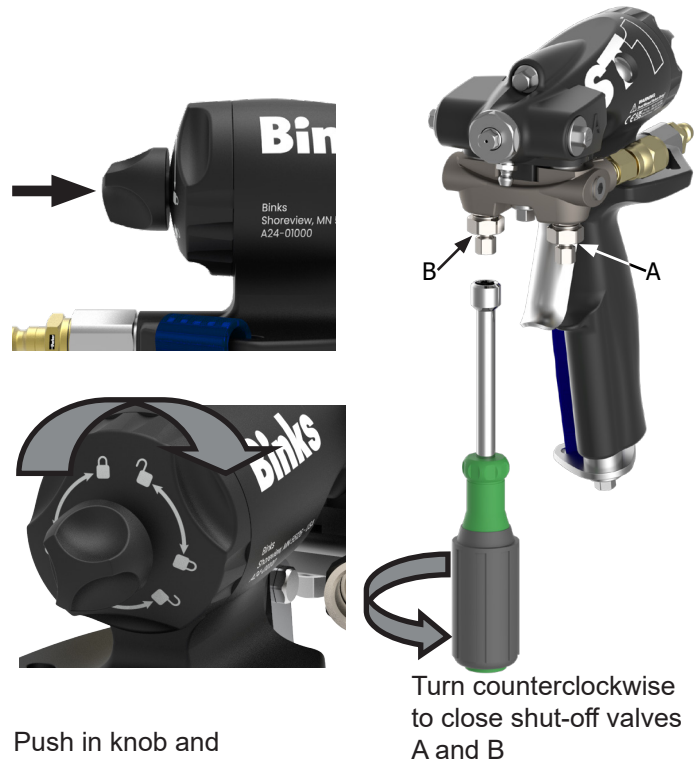

Push in knob and turn clockwise to lock and stop fluid.

**⚠ WARNING**

A damaged o-ring in the air valve can cause the gun to keep spraying.

**SHUT OFF THE AIR IMMEDIATELY!**

Then engage safety stop. Push the knob in and turn clockwise. Shut off manual valves.

**06.7 GETTING STARTED, SET-UP**

1. Close A-side and B- Side shut off valves on the fluid manifold.

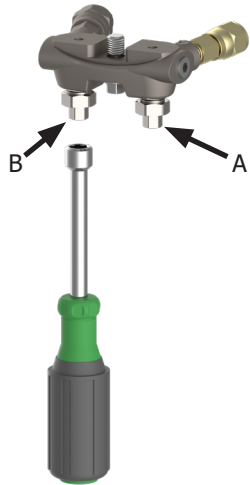

2. Connect A (ISO) and B (Resin) hoses to the fluid manifold.

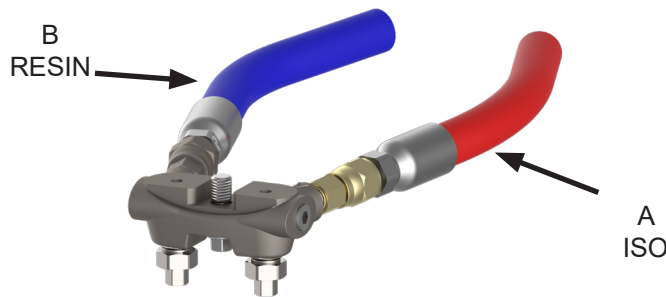

3. Engage the safety stop/lock on the gun.



4. Connect the fluid manifold (with the A and B hoses) to the spray gun. Connect the ball valve to 18" Air hose and connect the main air to the ball valve. Use the quick disconnect coupler to connect air to the spray gun.

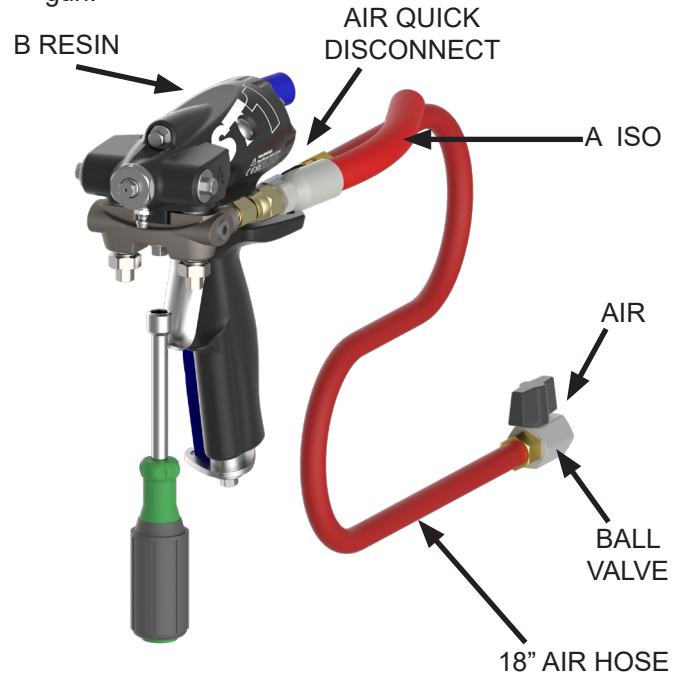

5. Turn on air and open ball valve (air). Air should now flow through the mix tip when the gun is not triggered.
6. Keep the shutoff valve closed. Disengage the safety stop/lock and trigger the spray gun. The piston will actuate. Observe the mix tip position. When triggered, the mix tip should come about flush with the front of the gun, and airflow should stop.
7. Apply a layer of lubricant over the front of the gun to prevent overspray.



Not Triggered

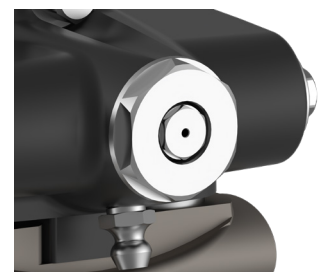

Triggered—mix tip comes flush with front.



8. Press the safety stop/lock in and turn clockwise to lock the gun.
9. Turn on the proportioner. Follow all manufacturer's instructions for starting the proportioner.



10. Using a 5/16" nut driver turning counterclockwise, fully open the B (resin) shut-off valve. Then open the A (ISO) shut-off valve.

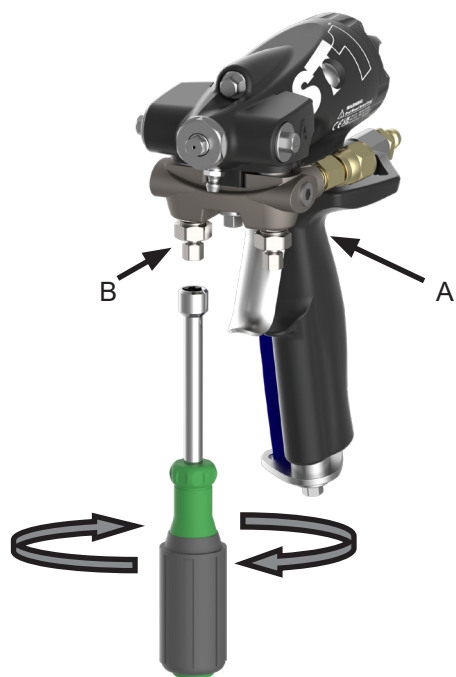

11. Turn the safety stop/lock counterclockwise to disengage the safety.
12. Test spray onto cardboard or plastic, adjust temperature and pressure settings to achieve desired results.



13. When pressure and temperature is set, and the foam is satisfactory, the gun is ready to spray.

### ⚠ CAUTION

Air supply is required for gun actuation. Do not disconnect gun air supply until fluid pressure is relieved



06.8 PRESSURE RELIEF AND SHUT DOWN

**! WARNING**

Relieve pressure before cleaning or repairing gun.

1. Press in and turn clockwise to engage the safety stop/lock.



**! CAUTION**

Air supply is required for gun actuation. Do not disconnect gun air supply until fluid pressure is relieved.

2. Using a 5/16" nut driver and turn clockwise to shut off the A and B valves.



3. Push in and turn counterclockwise to disengage safety stop/lock.
4. Trigger the gun onto cardboard or into a waste container to relieve pressure.



5. Press in and turn clockwise to engage the safety stop/lock.



**! WARNING**

Fluid in the hose and proportioner is still under pressure, Follow the Pressure Relief Procedure in the proportioner manual.

To relieve pressure in the hose after the gun is removed, place the fluid manifold over containers, facing away from you. Very carefully open the shut-off valves. Be aware that the fluid will spray sideways from the fluid ports when under pressure. **OPEN SLOWLY.**

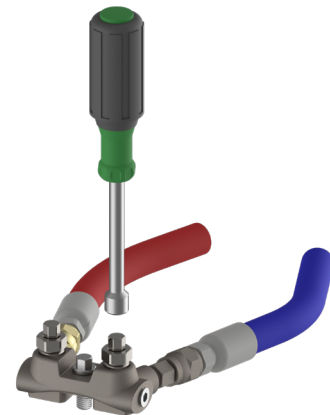

### 06.9 REPOSITION HOSES (OPTIONAL)

The fluid and air hoses normally point to the rear of the ST1™ gun. They may be repositioned to point down using the Bottom Air Inlet Kit (PN: 336409).

#### ⚠ CAUTION

To prevent cross contamination of wetted parts, do not interchange A component (ISO) and B component (RESIN) parts

1. Disconnect fluid hoses from the fluid manifold.
2. Follow the pressure relief procedure in section 06.8. Shut off proportioner and relieve system pressure.



3. Disconnect air and remove fluid manifold.

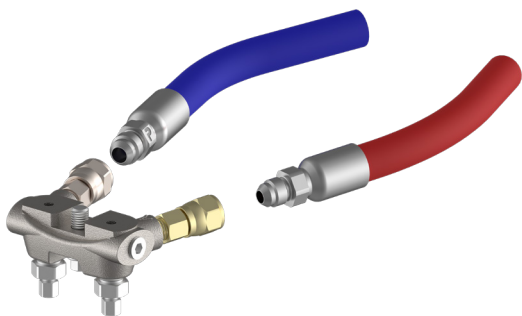

4. Remove swivels and plugs from the fluid manifold. Note that A-side swivel is smaller than B-side swivel.

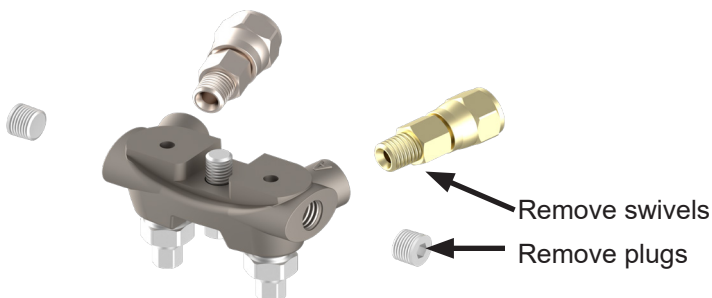

5. Apply thread sealant to plugs removed in step 4 and reinstall as shown. Use the elbows from the Bottom Air Inlet Kit (PN: 336409) and install into the fluid manifold as shown. Install the swivels into the elbows. Make sure that the smaller swivel is on the A Side. Reattach the A and B hoses making sure that all A components are on their correct side and B components are on their correct side.
6. Remove the stud from the bottom of the gun and install the bottom air inlet fitting.

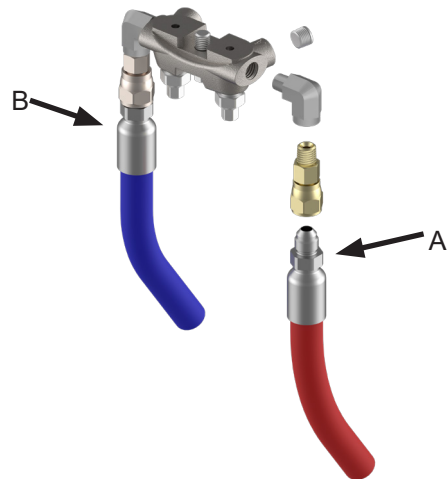

7. Remove quick disconnect stem from the rear air inlet and install a 1/4" NPT plug into the rear air inlet.

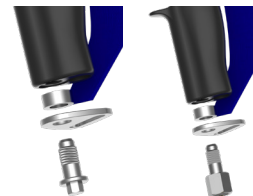

8. Install the Quick Disconnect stem into the bottom air inlet fitting.



9. Attach the fluid manifold and reconnect air.



## 07. MAINTENANCE

Before a job — Apply a release agent or light coat of lubricant to the outside of the gun prior to spraying to make cleaning easier.

As needed:

- Clean outside of gun with a compatible solvent.
- Use N Methyl Pyrrolidone (NMP), Dynaloy®-brand Dynasolve (CU-6, SB Veraflex-brand Dzolv®), or equivalent to soften cured material.  
NOTE: The cleaning solvent is not recommended for flushing.
- Clean the mix tip. Use correct drill bit. Soak in recommended solvent to soften cured material.  
NOTE: The drill bit may be dipped in solvent to aid in cleaning.
- Clean the mix chamber. Follow pressure relief procedure in section 06.8. After pressure is relieved, remove mix chamber from gun. Soak in recommended solvent to soften cured material. Use correct drill bit to clean impingement ports.
- Clean the muffler — Soak in recommended solvent.
- Clean fluid manifold — Keep sealing faces clean when manifold is removed from gun. Soak in recommended solvent. Do not scratch or damage the sealing faces. Apply a film of grease to the manifold port openings.

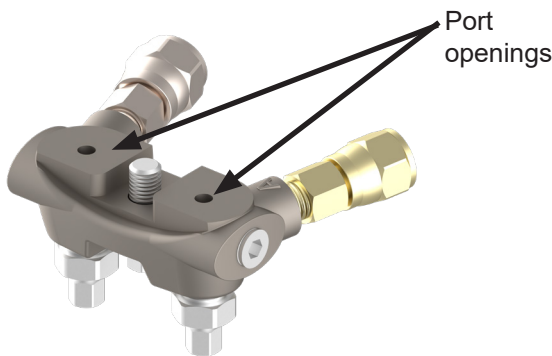

### 07.1 TOOLS

#### 336407 5/16" NUT DRIVER

Many components can be easily tightened or removed with a 5/16" nut driver including:

- Mix Tip
- Side seals
- Manifold Screw
- Manual Shut-off Valves
- Trigger Screw

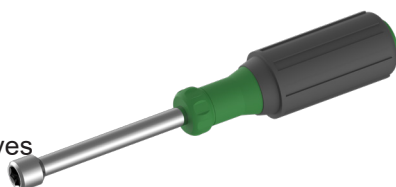

#### 336403 PIN VISE

The pin vise inserts are reversible and can be used with a variety of drill bits.

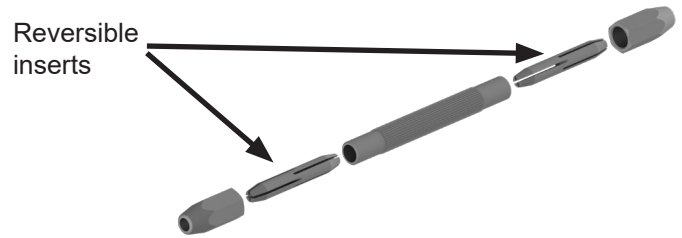

#### 336404 GREASE GUN

#### 336406 3oz GREASE CARTRIDGE

Assemble the grease gun as shown. Install the 3 oz cartridge of grease—remove the cap and install open end downward. Remove foil from the top end.

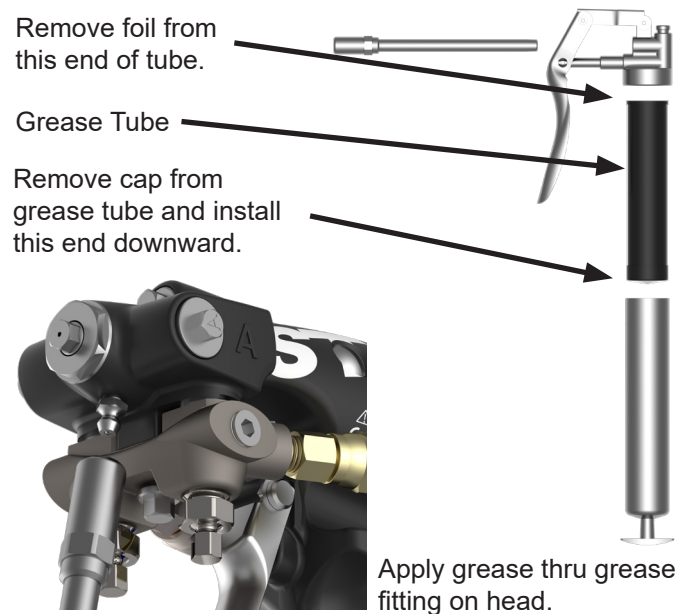

#### 336740 O-RING INSTALLATION TOOL

Use this tool to avoid damaging o-rings installed on Valve Stem and Rod & Piston Assembly.

Step 1



Step 3



Step 2



Step 4



## 07.2 MIX TIP MAINTENANCE

### ⚠ WARNING

Be sure that Safety Stop is engaged and manual shut-off valves are closed before changed mix chamber or mix tip components.

### 07.2.1 CLEANING MIX TIP IN PLACE

- Install the correct drill bit in the pin vise. Use the table below to determine the correct drill bit.
- Dip the drill bit in solvent to aid in cleaning.
- Carefully insert the drill bit into the mix tip. Use in/out and rotational motions to keep the drill bit straight and clean.



### MIX TIP AND DRILL BIT SIZES

Mix Tip Part No. (Drill Bit Included)	Tip Size	Drill Size, in (mm)
336452	00	#55, .052 (1.30)
336453	01	#53, .060 (1.50)
336454	15	#52, .064 (1.60)
336455	02	#50, .070 (1.75)
336456	03	#44, .086 (2.15)
336457	04	#42, .094 (2.35)

### 07.2.2 REMOVE MIX TIP FOR CLEANING

- Remove the mix tip with a 5/16" Nut Driver.
- Soak mix tip in cleaning solvent to soften hardened material.
- Install correct drill bit in pin vise. Carefully insert drill bit into mix tip. Keep drill bit straight and clean using in/out and rotational motions.



### 07.2.3 CHANGING MIX TIP

To easily change the pattern size and flow rate, the user can change the size of the mix tip. Use the following procedure to change mix tips:

1. Unscrew and remove mix tip using a 5/16" nut driver.
2. Install the new mix tip with a 5/16" nut driver, tighten securely.

### 07.3 MIX CHAMBER MAINTENANCE

#### ⚠ WARNING

Be sure that Safety Stop is engaged and manual shut-off valves are closed before changing mix chamber or mix tip components.

#### ⚠ CAUTION

To prevent cross contamination of wetted parts, do not interchange A component (ISO) and B component (RESIN) parts.

Use the following procedure to remove and clean the mix chamber:

1. Follow the pressure relief procedure in section 06.8.
2. After shutting off manual valves, remove gun from manifold. (Manifold to remain attached to the hose.)
3. Flush gun with a compatible solvent following flush procedure in section 07.4.
4. Unscrew and remove mix tip with a 5/16" nut driver.
5. Loosen the A and B side seal cartridges (items G and H in section 06.4) so that the mix chamber can easily slide out when the head is removed from the handle.



6. NOTE: If necessary, fully remove the side seal cartridges and inspect the side seals. Replace side seals if worn.
7. Use 5/16" Nut Driver to remove the head assembly from the gun handle.



8. Clean the mix chamber's impingement ports with the appropriate drill bit. See the table on this page to determine correct drill bit size.

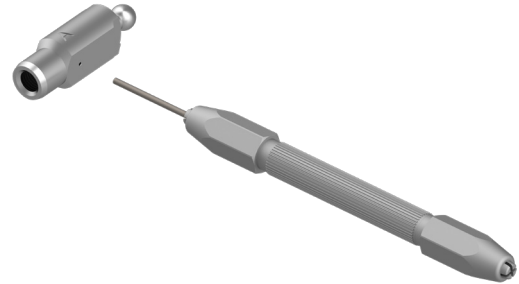

9. Soften hardened material by soaking mix chamber in a cleaning solvent. Then use drill bit.

#### MIX CHAMBER AND DRILL BIT SIZES

Mix Chamber Part No. (Drill Bit Included)	Size	Drill Size, in (mm)
336446	A	#68, .031 (.787)
336447	B	#58, .042 (1.00)
336448	C	#56, .042 (1.15)
336449	D	#55, .052 (1.30)
336450	E	#53, .060 (1.50)
336451	F	#50, .070 (1.75)

10. Install the cleaned mix chamber, or install a new mix chamber. Couple the ball end to the piston rod.
11. Slide the head over the mix chamber and tighten the screw.
12. Tighten the side seal cartridges securely.

#### NOTICE

Do not mix the side seal cartridges.



## 07.4 GUN FLUSHING PROCEDURE

Use the Flush Manifold Kit (PN 336436) and the following procedures to flush the spray gun.

### Assemble the flush manifold.

- Apply PTFE tape to the male threads of a 1/4 NPT plug and a fitting that will accept the solvent flush line, (a male Quick Disconnect stem is shown for reference) and tighten securely into the manifold block.

### Flushing the spray gun:

- Follow the pressure relief procedure in section 06.8.
- Ensure that safety stop is in the locked position and the manual valves are closed shut.

## NOTICE

If necessary, fully remove the side seal cartridges and inspect the side seals. Replace side seals if worn.

- Turn off air supply to the gun.
- Remove the fluid manifold from the gun.
- Install the flush manifold onto the gun. The flush manifold can be attached in either direction.



- Connect flushing solvent source to flush manifold. Use a suitable flushing solvent.
- When ready to flush, open air valve and turn the safety stop knob to the unlocked position.

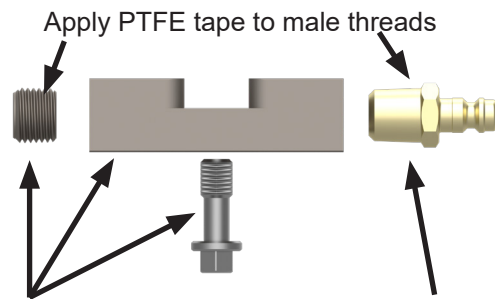

Included with 336436  
Flush Manifold

Use fitting that works  
with your equipment

- Point gun into a suitable waste container and trigger gun.
- When flushing is complete, turn the safety stop knob to the locked position.
- Close the air valve.
- Remove the flush manifold from the gun.
- Before reinstalling fluid manifold to spray gun, apply grease to the check valve face o-rings and the top sealing faces of the fluid manifold, and reassemble the gun to the manifold.

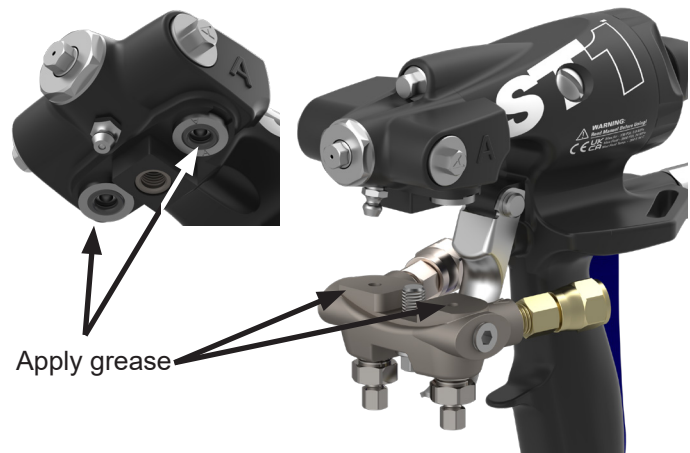

- Apply one shot of fresh grease to the gun through the grease fitting.

## 07.5 HEAD ASSEMBLY SERVICING

### ⚠ WARNING

Relieve pressure before cleaning or repairing the gun.

### ⚠ WARNING

Be sure that Safety Stop is engaged and manual shut-off valves are closed before changing mix chamber or mix tip components.

### ⚠ CAUTION

To prevent cross contamination of wetted parts, do not interchange A component (ISO) and B component (RESIN) parts.

Use the following procedure to service the spray gun head assembly:

1. Relieve pressure from the spray gun. Use the procedure in section 06.8.
2. Ensure the safety stop is in the locked position and the manual shut off valves on the fluid manifold are closed.
3. Use a 5/16" nut driver to loosen the A and B side seal cartridges so the mix chamber can easily slide out when the head is removed from the handle.
4. Use a 5/16" nut driver to loosen the retaining screw and remove the head from the handle.

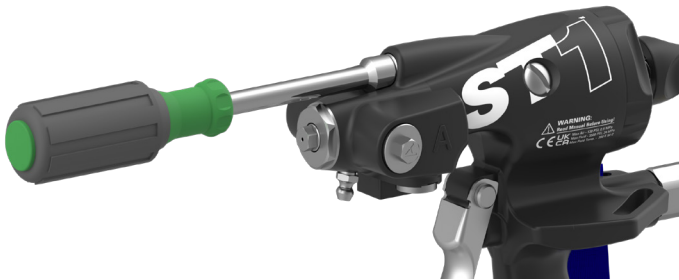

### 07.5.1 SIDE SEAL SERVICING

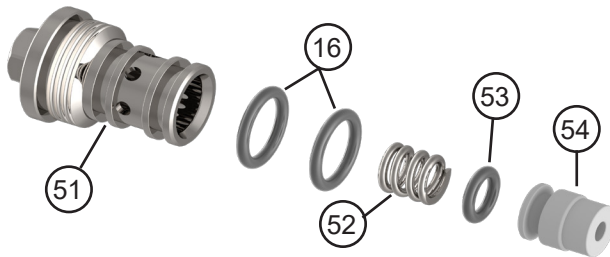

1. Use a 5/16" nut driver to remove the side seals from the gun head.
2. Inspect the side seal o-rings (items 16 and 53) for wear, replace if damaged.

3. Soak components in compatible solvent to soften dried/hardened material.
4. Before reassembly, ensure that the spring (item 52) is installed in the housing (item 51) before installing the side seal (items 8/9).
5. Apply grease to the side seal, o-rings, and housing threads.
6. Reinstall side seal assembly into the correct (A/B) port and tighten securely.

### 07.5.2 CHECK VALVE SERVICING

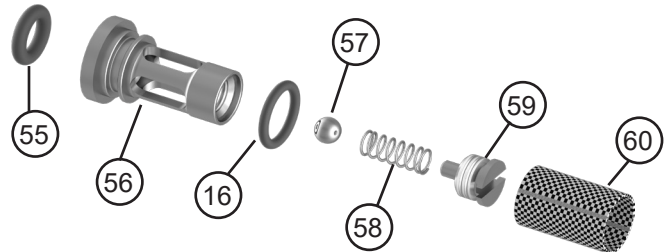

1. Use a flat tipped screw driver and carefully pry the check valves (items 10 and 11 in section 7.11) from the bottom of the head assembly.
2. Inspect o-rings (items 16 and 55) for wear. Replace if damaged.
3. Clean/replace filter screen if clogged.
4. Ensure that dried material is not inhibiting the ball (item 57) or spring (item 58). Soak valve or components in compatible solvent to soften dried/hardened material.
5. Use a flat tip screw driver to remove the spring retainer (item 59), and obtain access to the ball and spring.
6. Install cleaned/new ball and spring and tighten retainer until it stops flush with top of valve housing.
7. Apply grease to the o-rings and reinstall check valves into correct ports (A/B) on the spray gun head.

## 07.6 FLUID MANIFOLD ASSEMBLY SERVICING

### ⚠ WARNING

Relieve pressure before cleaning or repairing the gun.

### ⚠ WARNING

Be sure that Safety Stop is engaged and manual shut-off valves are closed before changing mix chamber or mix tip components.

### ⚠ CAUTION

To prevent cross contamination of wetted parts, do not interchange A component (ISO) and B component (RESIN) parts.

### NOTICE

Take care not to damage mating surfaces.

Use the following procedure to remove and service the fluid manifold assembly:

1. Relieve pressure from the spray gun. Use the procedure in section 06.8.
2. Ensure the safety stop is in the locked position and the manual shut off valves on the fluid manifold are closed.
3. Flushing the gun is recommended before performing maintenance. Follow the gun flush procedure in section 07.4.
4. Remove manifold assembly from the spray gun using a 5/16" nut driver.
5. Remove manifold assembly from hose. Plug and/ or arrange hoses to prevent A and B chemicals from running out of end of hose.
6. Inspect hose swivels (items 24 and 25), manual valves (item 22), plugs (item 23) and manifold screw (item 15) for damage. Clean or replace as needed.
7. Inspect manifold. Soak in compatible solvent to soften dried/hardened material. Wipe away any softened material. Use a stiff brush if necessary but do not scratch/damage the top mating surfaces.
8. If removing the manual valves, use a 5/16" nut driver and turn counterclockwise to open the valve fully, then use a wrench on the larger flats to remove valve from the manifold.

9. If removed, reinstall the manual valves into the manifold. Ensure that the valve is fully open and the ball tip is against the valve body (see below). Torque the larger hex to 23-26 ft-lbs.
10. After manual valves are installed, use a 5/16" nut and turn clockwise to fully close valve.
11. If removed, install swivel fittings. Apply PTFE tape to threads and tighten securely.

### NOTICE

The smaller fitting (item 24 / JIC 5) is installed on the A side. The fluid manifold has a raised A over the A swivel fitting port. The larger fitting (item 25 / JIC 6) is installed in the unmarked port.

12. If removed, apply PTFE tape to the pipe plugs (item 23) and install into side ports. Tighten securely. (See section 06.9 for alternate positioning of hose fittings and plugs)
13. Before reinstalling manifold onto spray gun, ensure manual valves are fully closed. Apply a thin layer of grease to the manifold ports and mating surface around the ports.

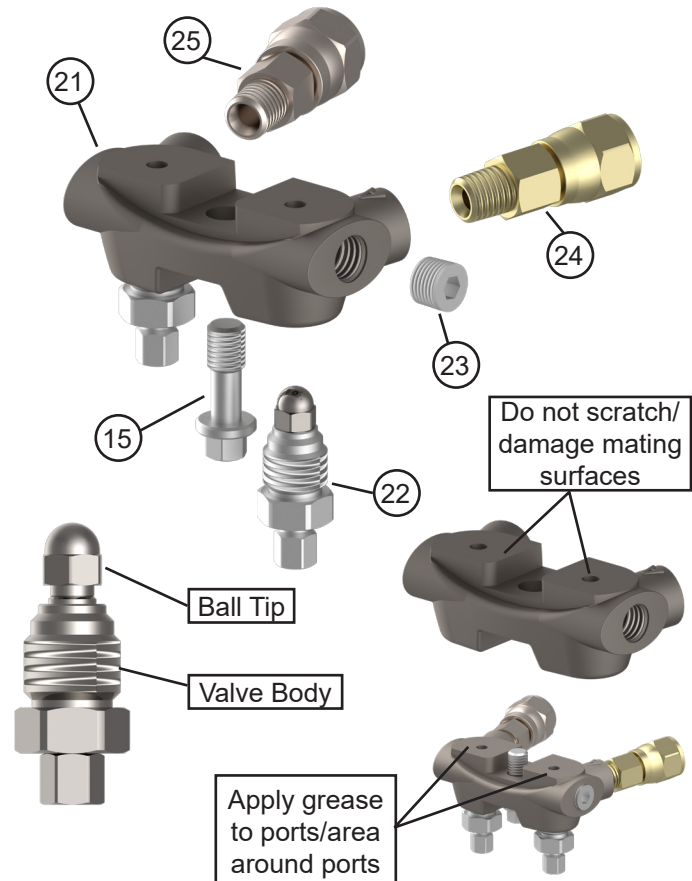



## 07.7 SAFETY STOP ASSEMBLY SERVICING

### ! WARNING

Relieve pressure before cleaning or repairing the gun.

Use the following procedure to remove and service the safety stop assembly.

1. Relieve pressure from the spray gun. Use the procedure in section 06.8.
2. Ensure the safety stop is in the locked position and the manual shut off valves on the fluid manifold are closed.
3. Flushing the gun is recommended before performing maintenance. Follow the gun flush procedure in section 07.4.
4. Remove manifold assembly from the spray gun using a 5/16" nut driver.
5. Unscrew the safety stop assembly from the rear of the gun handle.
6. Inspect the end cap o-ring (item 31) for damage. Replace if damaged.
7. To inspect and replace the knob stem o-ring (item 33), the lock-arm (item 29) must be removed.
8. Position the lock-arm in one of its slots. Place a cloth around the knob (to prevent damage) and grip with channel locks (or pliers). Unscrew the knob from the lock-arm. If the threads won't break free, heat threads briefly to soften the retaining compound.
9. Pull the stem from the end cap and remove the existing o-ring.
10. Clean the threads of the stem and lock arm. Soak in acetone to dissolve the retaining compound. Use wire brush and/or a pick-type tool to clean.
11. Install new o-ring (item 33)
12. Lubricate o-ring (item 33) and knob stem (item 34).
13. Install spring (item 32) over stem and insert the stem through the end cap (item 31).
14. Inspect lock arm (item 29), replace if damaged.
15. Apply thread retaining compound to the threads of the knob stem (item 34) and the lock-arm (item 29).
16. Hold the lock-arm into one of its slots and thread the knob stem into the lock-arm. Make sure that the lock-arm shoulders tight against the stem.
17. Wipe off excess retaining compound.
18. Allow the thread retaining compound to cure over night.

19. Apply grease to the end cap (24) threads and the end cap o-ring (29) and thread the safety stop assembly to the spray gun.



## 07.8 HANDLE ASSEMBLY SERVICE

**! WARNING**

Relieve pressure before cleaning or repairing the gun.

Certain assemblies must be removed to service the gun handle assembly. Refer to the following sections for those procedures:

- 07.5 Gun Head Assembly Servicing
- 07.6 Fluid Manifold Assembly Servicing
- 07.7 Safety Stop Assembly Servicing

Inspect the following components of the gun head assembly for damage and wear:

- Gun handle (item 1)
  - Check for damage around sealing surfaces and threads.
- Shaft guide (item 12) and o-ring (item 13)
  - Inspect shaft guide for damage and wear. Replace if necessary. Apply grease to new shaft guide.
  - Inspect o-ring for damage. Replace if necessary. Apply grease to new o-ring.
- Air check valve assembly (item 7)
  - Inspect for damage and correct operation.
  - If check valve needs to be replaced, remove from assembly using flat tip screw driver. Apply grease to threads and o-ring of replacement check valve.
- Trigger assembly (items 26-28)
  - Trigger assembly can be removed and installed using 5/16" nut driver.
  - See images to right for installation of trigger assembly.
- Air muffler (item 40)
  - Inspect air muffler for damage and clogs. Remove from handle using flat tip screw driver for cleaning or replacement.

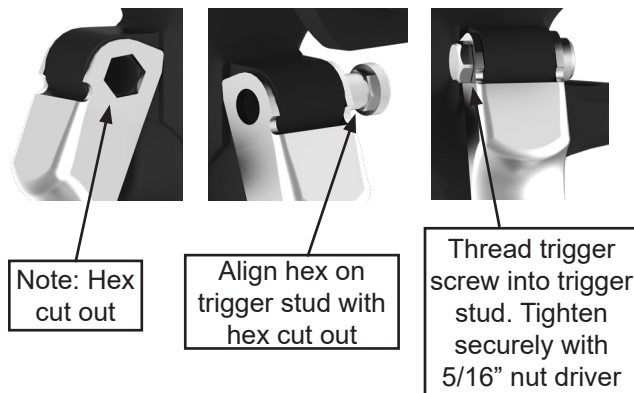

**07.8.1 HANDLE AND HEAD DRILL BIT KIT (336439)**

**! WARNING**

Relieve pressure cleaning before cleaning or repairing gun.

**NOTICE**

Do not drill into metal during clean-out operation

**! CAUTION**

These solvents are not to be used for flushing.

The Handle and Head Drill Bit Kit (PN 336439) is a kit containing different drill bits and intended for cleaning out the different ports and passages of the ST1™ spray gun handle.

Use the table below and images to the right to determine the correct drill bit needed to clean out the different ports and passages of the gun.

Use N Methyl Pyrrolidone (NMP), Dynaloy®-brand Dynasolve (CU-6, SB Veraflex-brand Dzolv®, or equivalent) to soften cured material.

Ref No.	Description	Drill Size
1	FLUID TRANSFER	No. 36(.1065)
2	PURGE AIR	No. 36(.1065)
3	PISTON AIR	No. 36(.1065)
4	AIR VALVE BORE	"T"(.358)
5	EXHAUST PORT (LG DIA.)	"Q"(.332)
5A	EXHAUST PORT (SM DIA.)	No. 31(.120)
6	OPTIONAL AIR INLET (LG DIA.)	"I"(.272)
6A	OPTIONAL AIR INLET (SM DIA.)	No. 31(.120)
7	GREASE CHANNELS	No. 58(.042)

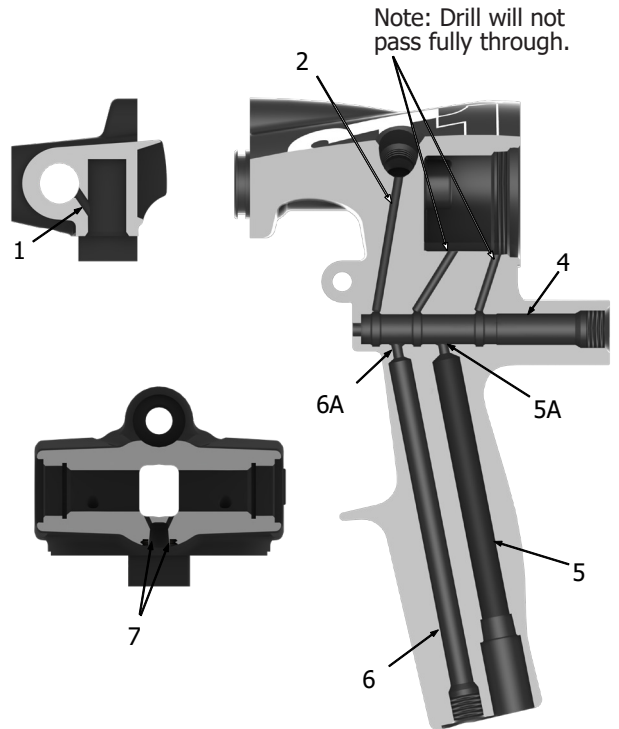

## 07.9 PISTON AND AIR VALVE ASSEMBLY SERVICE

### ⚠ WARNING

Relieve pressure before cleaning or repairing the gun.

To service the piston and air valve assembly, use the following procedure:

1. Relieve pressure from the spray gun. Use the procedure in section 06.8.
2. Ensure the safety stop is in the locked position and the manual shut off valves on the fluid manifold are closed.
3. Flushing the gun is recommended before performing maintenance. Follow the gun flush procedure in section 07.4.
4. Close ball valve on air supply line and disconnect air line from gun.

To remove the piston assembly from the gun:

5. Remove the head assembly. Follow the procedure in section 07.5.
6. Remove the safety stop assembly. Follow the procedure in section 07.7.
7. Push on piston end that is protruding from through the shaft guide until piston assembly comes free out the back of the gun.

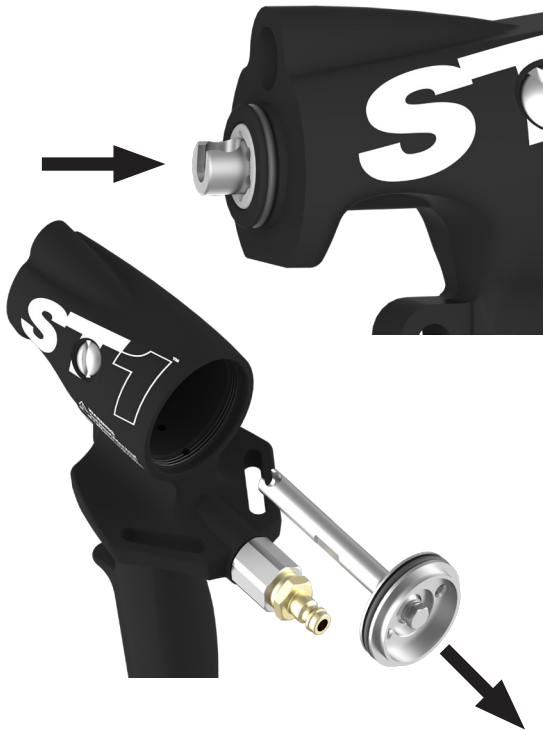

8. Inspect the piston assembly rod, piston, and o-ring for wear and damage. Replace o-ring and/or piston assembly if damaged.
9. Apply grease to piston rod and piston o-ring, carefully insert rod through guide with mix chamber notch facing up. Firmly press piston into place.

To remove the air valve assembly:

10. Use a wrench on the flats of the quick disconnect base and turn counterclockwise to remove the air valve assembly.
11. Remove quick disconnect, spring, and valve stem assembly from gun handle.
12. Inspect valve stem and o-rings for damage and wear. Replace if damaged. Use o-ring installation tool (PN 336740) to avoid damaging o-rings during installation.



13. Apply a thin layer of grease to the air valve stem.
14. Carefully install air valve stem into gun handle. Nose of valve stem should protrude through the front of the handle.
15. Install spring into recess in back of valve stem. Install the quick disconnect into the back of gun.

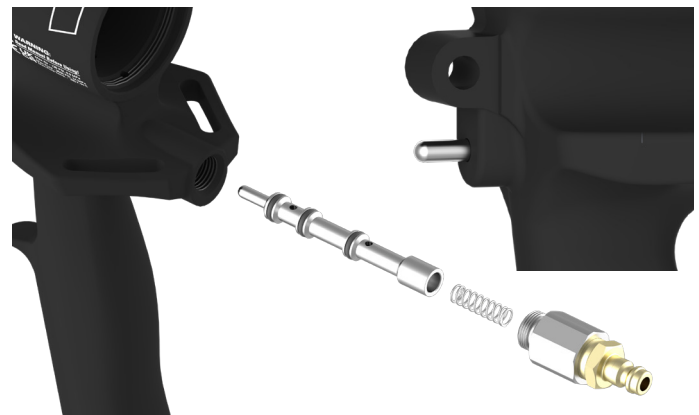

16. Torque quick disconnect to 90-95 in-lbs.

### 07.10 STRAP INSTALLATION

The ST1™ can be configured for either left or right handed use.

Thread the strap through the swiveling clip at the base of the gun, then through the left or right slots at the top of the grip so the BINKS logo is facing outward.

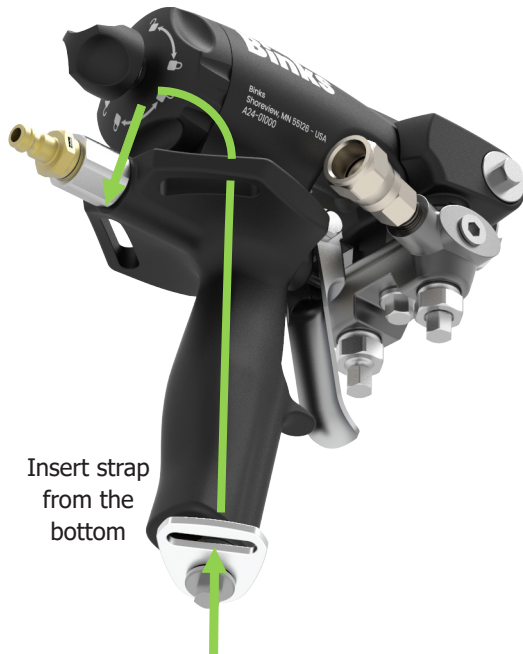

This page intentionally left blank.

07.11 SPRAY FOAM GUN COMPONENTS

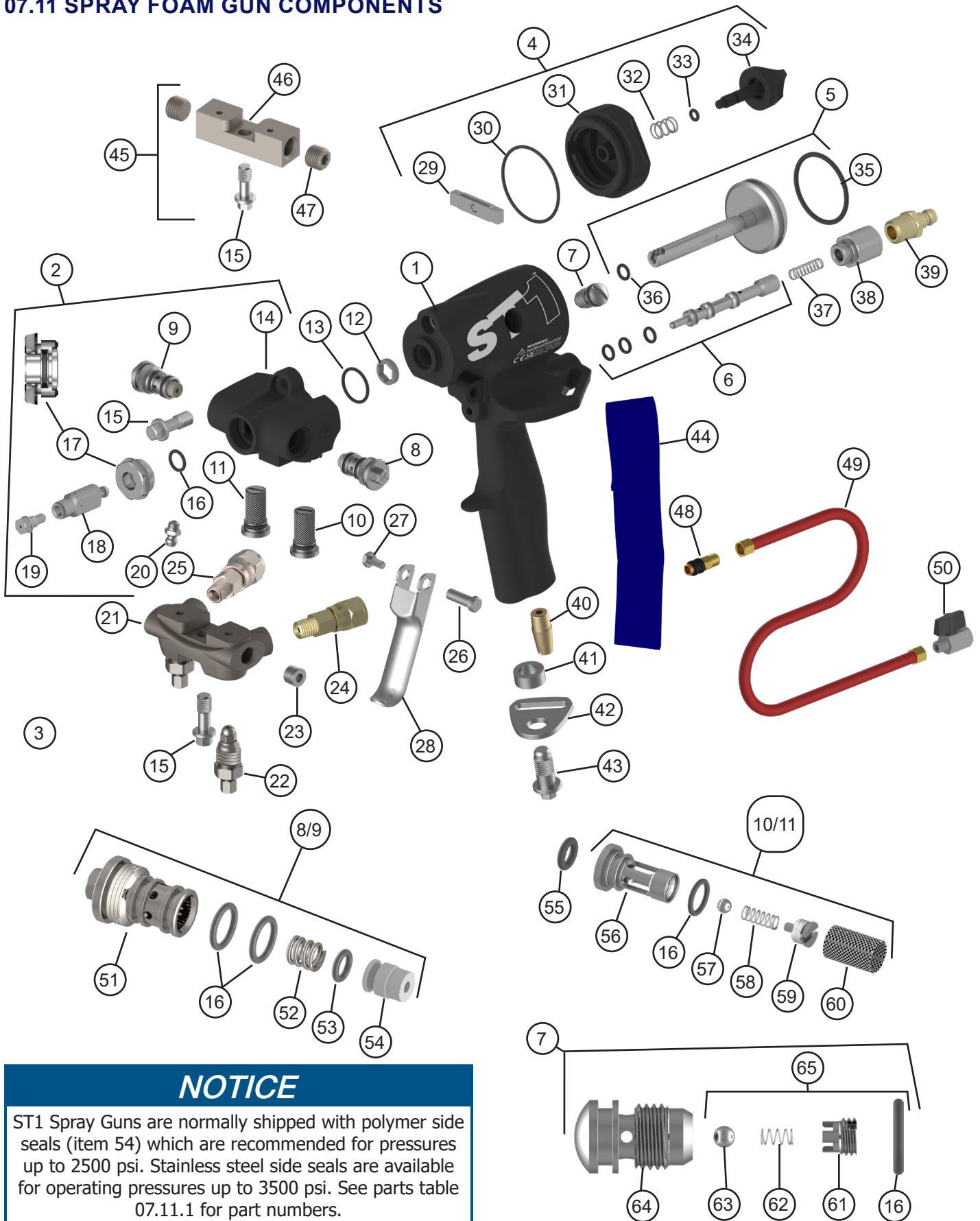

**NOTICE**

ST1 Spray Guns are normally shipped with polymer side seals (item 54) which are recommended for pressures up to 2500 psi. Stainless steel side seals are available for operating pressures up to 3500 psi. See parts table 07.11.1 for part numbers.



## 07.11.1 ST1™ SPRAY GUN COMPONENTS

ITEM #	PART #	DESCRIPTION	QTY
1	336352	GUN HANDLE	1
2	336426	FRONT END ASSEMBLY (INCL. 8-11, 14-17, 20)	1
3	336354	FLUID MANIFOLD ASSEMBLY (INCL. 15, 21-25)	1
4	336429	SAFETY STOP ASSEMBLY (INCL. 29-34)	1
5	336370	ROD AND PISTON ASSEMBLY (INCL. 35-36)	1
6	336366	VALVE STEM ASSEMBLY (INCL. O-RINGS)	1
7	336394	CHECK VALVE ASSEMBLY, AIR (INCL. 16, 61-64)	1
8	336375	SIDE SEAL CARTRIDGE, A-SIDE, POLY (INCL. 16, 51-53)	1
	336430	SIDE SEAL CARTRIDGE, A-SIDE, SS (INCL. 16, 51-53)	
9	336376	SIDE SEAL CARTRIDGE, B-SIDE, POLY (INCL. 16, 51-53)	1
	336431	SIDE SEAL CARTRIDGE, B-SIDE, SS (INCL. 16, 51-53)	
10	336360	CHECK VALVE ASSEMBLY, A-SIDE (INCL. 16, 55-60)	1
11	336361	CHECK VALVE ASSEMBLY, B-SIDE (16, 55-60)	1
12	336359	SHAFT GUIDE, DELRIN	1
13	336417	O-RING, HEAD/HANDLE JUNCTION, 2 PK	1
14	336353	GUN HEAD	1
15	336356	MANIFOLD SCREW, 2PK	2
16	336415	O-RING, GUIDE AND HOUSING, 10 PK	8
17	336437	GUIDE ASSEMBLY (INCL. 16)	1
18	SEE TABLE 07.12.2	MIX CHAMBER	1
19	SEE TABLE 07.12.3	MIX TIP	1
20	336738	GREASE FITTING	1
21	336355	FLUID MANIFOLD	1
22	336372	FLUID MANIFOLD VALVE ASSEMBLY	2
23	336335	PIPE PLUG, 1/8" NPT, SS	2
24	336357	SWIVEL ADAPTER, A-SIDE	1
25	336358	SWIVEL ADAPTER, B-SIDE	1
26	336364	TRIGGER STUD	1
27	336365	TRIGGER SCREW	1
28	336363	TRIGGER	1
29	336736	LOCK ARM	1
30	336420	O-RING, END CAP, 2PK	1
31	336373	END CAP	1
32	336735	SPRING	1
33	336413	O-RING, SAFETY STOP, 2PK	1



## 07.11.1 ST1™ SPRAY GUN COMPONENTS

ITEM #	PART #	DESCRIPTION	QTY
34	336737	SAFETY STOP KNOB	1
35	336419	O-RING, AIR PISTON, 2PK	1
36	336412	O-RING, AIR VALVE/PISTON ROD, 10PK	4
37	336367	SPRING	1
38	336395	QUICK DISCONNECT BASE	1
39	336396	QUICK DISCONNECT STEM	1
40	336374	MUFFLER	1
41	336400	SPACER	1
42	336399	GUN CLIP	1
43	336401	STUD	1
44	336398	STRAP	1
45	336436	FLUSH MANIFOLD ASSEMBLY (INCL. 15, 46-47)	1
46	336433	FLUSH MANIFOLD	1
47	336336	PIPE PLUG, 1/4" NPT SS	2
48	336397	QUICK DISCONNECT AIR LINE COUPLER	1
49	336643	HOSE ASSEMBLY	1
50	336408	BALL VALVE	1
51	336377	SIDE SEAL CARTRIDGE HOUSING A	1
	340564	SIDE SEAL CARTRIDGE HOUSING B	1
52	336378	SPRING, SIDE SEAL	1
53	336414	O-RING, SIDE SEAL, 10PK	1
54	336379	SIDE SEAL, POLY, 2PK W/ O-RINGS	2
	336381	SIDE SEAL, POLY, 50PK W/ O-RINGS	
	336410	SIDE SEAL, SS, 2PK W/ O-RINGS	
	336411	SIDE SEAL, SS, 50PK W/O-RINGS	
55	336418	O-RING, CHECK VALVE FACE, 10PK	2
56	NA	CHECK VALVE HOUSING	2
57	336427	BALL, CHECK VALVE, 10PK	2
58	336362	SPRING, CHECK VALVE	2
59	NA	SPRING RETAINER	2
60	336422	SCREEN, 40 MESH, 10PK	2
	336423	SCREEN, 60 MESH, 10PK	
61	NA	SPRING STOP	1
62	NA	SPRING	1
63	NA	BALL	1

## 07.11.1 ST1™ SPRAY GUN COMPONENTS

ITEM #	PART #	DESCRIPTION	QTY
64	NA	HOUSING	1
65	336428	AIR VALVE REPAIR KIT (INCL 10, 61-63)	1

## 07.12 MIX CHAMBERS AND MIX TIPS

The following tables contain information on the standard mix chambers (18) and mix tips (19), as well as extension mix tips, hardened mix tips, pour tips, and variable ratio mix chamber/mix tip. See chapters 07.2 and 07.3 for mix chamber and mix tip maintenance instructions.

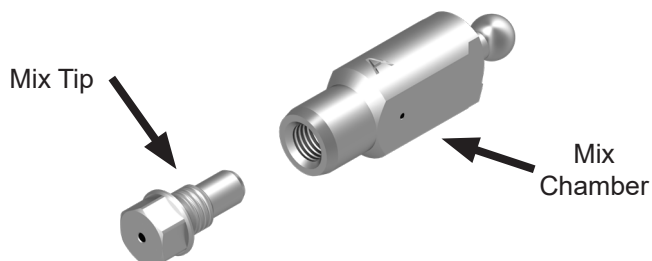

## 07.12.1 STANDARD MIX CHAMBER (18) / MIX TIP (19) COMBINATIONS (INCL. DRILL BIT)

PART NUMBER	MIX CHAMBER	MIX TIP	EQUIVALENT
336440	A	00	2929
336441	B	01	4242
336442	C	15	4747
336443	D	02	5252
336444	E	03	6060
336445	F	04	7070

## 07.12.2 INDIVIDUAL MIX CHAMBERS (INCL. DRILL BIT)

PART NUMBER	MIX CHAMBER	DRILL BIT #
336446	A	#68 (.031)
336447	B	#58 (.042)
336448	C	#56 (.047)
336449	D	#55 (.052)
336450	E	#53 (.060)
336451	F	#50 (.070)

## 07.12.3 INDIVIDUAL MIX TIPS (INCL. DRILL BIT)

PART NUMBER	MIX TIP	EQUIVALENT
336452	00	#55 (.052)
336453	01	#53 (.060)
336454	15	#52 (.064)
336455	02	#50 (.070)
336456	03	#44 (.088)
336457	04	#42 (.093)

**07.12.4 EXTENSION MIX TIPS (INCL. DRILL BIT)**

PART NUMBER	SIZE	ADDED LENGTH
336458	01 XS (.060)	1/2"
336459	01 XL (.060)	1"
336460	15 XS (.064)	1/2"
663461	15 XL (.064)	1"
336462	02 XS (.070)	1/2"
336463	02 XL (.070)	1"

**07.12.5 HARDENED MIX TIPS (INCL. DRILL BIT)**

PART NUMBER	SIZE	EQUIVALENT
336802	01	(.060)
336803	15	(.064)
336804	02	(.070)
336805	03	(.088)
336806	04	(.093)

**07.12.6 POUR TIPS (INCL. DRILL BIT)**

PART NUMBER	SIZE	EQUIVALENT
336639	01	(.060)
336640	02	(.070)
336641	03	(.088)

**07.12.7 VARIABLE RATIO MIX CHAMBER (18) / MIX TIP (19) KIT (INCL. DRILL BIT)\***

PART NUMBER	MIX CHAMBER SIZE	MIX TIP SIZE	DRILL BITS NO.
336750	D/A CHAMBER RATIO (1:0.36)	02	49, 50, 55, 68
336751	D/B CHAMBER RATIO (1:0.66)	02	45, 50, 55, 58
336752	E/B CHAMBER RATIO (1:0.50)	03	40, 44, 53, 55
336753	E/D CHAMBER RATIO (1:0.77)	03	41, 42, 50, 58
336754	F/B CHAMBER RATIO (1: 0.36)	04	41, 42, 50, 58
336755	F/E CHAMBER RATIO (1:0.72)	04	33, 42, 50, 53

\* IS30 and IS40 Variable Ratio software key is required to operate in variable ratio mode.

See IntelliSpray™ IS30 user manual 347492 and IS40 user manual 341162 for more information.

**07.13 SPARE PARTS AND ACCESSORIES**

The following tables contain various spare parts and accessories for the ST1 spray gun.

If an item number is listed it refers to the illustration in section 07.11.

**07.13.1 O-RING QUANTITY PACKS**

PART #	ITEM #	DESCRIPTION	QTY
336412	36	AIR VALVE, PISTON ROD O-RING	10
336413	33	SAFETY STOP O-RING	2
336414	53	SIDE SEAL O-RINGS	10
336415	16	GUIDE & HOUSING O-RING, MIX CHAMBER GUIDE, SIDE SEAL, AIR & FLUID CHECK VALVE O-RINGS	10
336417	13	HEAD & HANDLE JUNCTION O-RING	2
336418	55	CHECK VALVE FACE O-RING	10
336419	35	AIR PISTON O-RING	2
336420	30	END CAP O-RING	2
336416	NA	WETTED PARTS O-RING KIT (SEE TABLE 07.7.2 FOR INCLUDED PARTS)	KIT
336421	NA	COMPLETE O-RING KIT (SEE TABLE 07.7.3 FOR INCLUDED PARTS)	KIT

**07.13.2 WETTED PARTS O-RING KIT 336416**

ITEM #	DESCRIPTION	QTY
53	SIDE SEAL O-RINGS	2
16	GUIDE & HOUSING O-RING, MIX CHAMBER GUIDE, SIDE SEAL, AIR & FLUID CHECK VALVE O-RINGS	7
55	CHECK VALVE FACE O-RING	2

**07.13.3 COMPLETE O-RING KIT 336421**

ITEM #	DESCRIPTION	QTY
36	AIR VALVE, PISTON ROD O-RING	4
33	SAFETY STOP O-RING	1
53	SIDE SEAL O-RINGS	2
16	GUIDE & HOUSING O-RING, MIX CHAMBER GUIDE, SIDE SEAL, AIR & FLUID CHECK VALVE O-RINGS	8
13	HEAD & HANDLE JUNCTION O-RING	1
55	CHECK VALVE FACE O-RING	2
35	AIR PISTON O-RING	1
30	END CAP O-RING	1

**07.13.4 MIX CHAMBER CLEAN-OUT DRILL BITS**

PART #	DESCRIPTION	SIZE	QTY
336464	NO. 68 DRILL (.031)	A	6
336465	NO. 58 DRILL (.042)	B	6
663466	NO. 56 DRILL (.0465)	C	6
336467	NO. 55 DRILL (.052)	D	6
336468	NO. 53 DRILL (.0595)	E	6
336470	NO. 50 DRILL (.070)	F	6

**07.13.5 MIX TIP CLEAN-OUT DRILL BITS**

PART #	DESCRIPTION	SIZE	QTY
336467	NO. 55 DRILL (.052)	00	6
336468	NO. 53 DRILL (.0595)	01	6
336469	NO. 52 DRILL (.070)	15	6
336470	NO. 50 DRILL (.070)	02	6
336471	NO. 44 DRILL (.086)	03	6
336472	NO. 42 DRILL (.0935)	04	6

**07.13.6 ACCESSORIES, SPARE KITS, AND TOOLS**

PART #	DESCRIPTION
336402	QUICK DISCONNECT BASE BOTTOM INLET
336403	PIN VISE, DOUBLE ENDED
336404	GREASE GUN, PLEWS 30-100
336405	3 OZ GREASE CARTRIDGE, 4PK
336406	3 OZ GREASE CARTRIDGE
336407	5/16 NUT DRIVER
336409	BOTTOM AIR INLET KIT
336424	COMPLETE GUN SPARES KIT
336428	REPAIR KIT, AIR CHECK VALVE
336439	DRILL BIT KIT, HANDLE AND HEAD
336740	TOOL, O-RING INSTALLATION
336642	GUN CLEANING KIT
347411	COVER, ST1 SPRAY GUN
347541	AIR HOSE FITTING REPAIR KIT - M/F
347672	ST1 ESSENTIALS PARTS KIT

This page intentionally left blank.

## 08. TROUBLESHOOTING

**! WARNING**

Relieve pressure before cleaning or repairing the spray gun.

**! WARNING**

Be sure that the Safety stop is engaged and the manual shut-off valves are closed before performing maintenance.

**! CAUTION**

To prevent cross contamination of wetted parts, do not interchange A component (ISO) and B component (RESIN) parts.

The following table contains information on troubleshooting the ST1™ Spray Foam Gun. It lists possible issues a user may experience, the probable cause(s), and the solution(s).

Check all possible problems and causes before disassembling the spray gun.

TROUBLE SHOOTING PROCEDURES		
PROBLEM	CAUSE	SOLUTION
Gun does not fully actuate when triggered	Safety lock engaged	Disengage safety lock
	Plugged muffler	Clean
	Damaged air valve o-rings	Replace
Fluid does not spray when gun is fully actuated	Closed fluid shut off valves	Open
	Plugged impingement ports	Clean
	Plugged check valves	Clean valves and/or replace screens
Gun actuates slowly	Plugged muffler	Clean
	Damaged piston o-rings	Replace
	Dirty air valve or damaged o-rings	Clean air valve or replace o-rings
Gun delays, then actuates abruptly	Cured material around side seals	Inspect side seals and mix chamber for scratches. Clean or replace if required.
Gun does not stop spraying when trigger is released	Damaged valve stem o-ring	Replace o-rings
Loss of round pattern	Dirty mix tip	Clean
Pressure imbalance	Plugged impingement ports	Clean
	Plugged check valves	Clean
	Viscosities not equal	Adjust temperature to compensate
	Dirty filter screens	Clean
A and/or B fluid in gun air section	Damaged side seals	Replace
	Damaged mix chamber	Replace
	Damaged side seal o-rings	Replace

TROUBLE SHOOTING PROCEDURES		
PROBLEM	CAUSE	SOLUTION
Fluid mist from mix chamber or air cap	Damaged side seals	Replace
	Damaged side seal o-rings	Replace
	Damaged mix chamber	Replace
Excessive overspray	Fluid pressure too high	Reduce
	Incorrect size mix chamber and/or mix tip for job	Select appropriate mix chamber and tip. Adjust the pressure and temperature accordingly
Rapid buildup of material on mix tip	Too little purge air	Increase
	Mix tip not fully tightened	Tighten
	Damaged mix chamber	Replace
	Damaged/Missing fluid handle/head o-ring	Replace
	Damaged guide o-ring	Replace
Reduced purge air	Damaged guide o-ring	Replace
	Air check valve clogged or damaged	Clean or replace
	Air check valve o-ring damaged	Replace
Fluid does not shut off when fluid shut-off valves are closed	Damaged fluid valves	Replace
Burst of air from muffler when gun is triggered	Normal	No action required
Steady air leakage from muffler	Damaged air valve o-rings	Replace
	Damaged piston o-rings	Replace
Air leakage from front of air valve	Damaged air valve o-rings	Replace
Air leak around handle/head junction	Damaged/missing fluid handle/head o-ring	Replace
Air leak from air check valve	Worn o-ring	Replace



## 09. WARRANTY POLICY

This product is covered by Binks' materials and workmanship limited warranty.

The use of parts or accessories from sources other than Binks will void all warranties. Failure to follow reasonable maintenance guidance provided can invalidate the warranty.

For specific warranty information, please contact Binks.

---

For technical assistance or to locate an authorized distributor, contact one of our international sales and customer support locations listed below.

REGION	BINKS CONTACT
Americas	Tel: 1-800-992-4657
Europe, Africa, Middle East	Tel: +4401202571111
India	marketingroa@binks.com
China	Tel: +862133730108
Korea	Tel: +82313663303
Japan	Tel: +81457856421
Australia	Tel: +61085257555





Binks is a global leader in innovative finishing technologies.  
Binks reserves the right to modify equipment specifications without prior notice.  
Binks®, DeVilbiss® and Ransburg® are registered trademarks of Binks US, LLC.