

Fusion[®] AP Spray Gun

309550ZAS

EN

Plural component, impingement mix air purge spray gun for dispensing non-flammable foam and polyurea. For professional use only.

Not approved for use in European explosive atmosphere locations.

3500 psi (24.5 MPa, 245 bar) Maximum Fluid Working Pressure

80-130 psi (0.56-0.9 MPa, 5.6-9.0 bar) Air Inlet Pressure Range

200°F (94°C) Maximum Fluid Temperature

See page 4 for model information.



Important Safety Instructions

Read all warnings and instructions in this manual and in all related manuals before using the equipment. Save these instructions.



Important Medical Information

Read the medical alert card provided with the gun. It contains injection injury treatment information for a doctor. Keep it with you when operating the equipment.

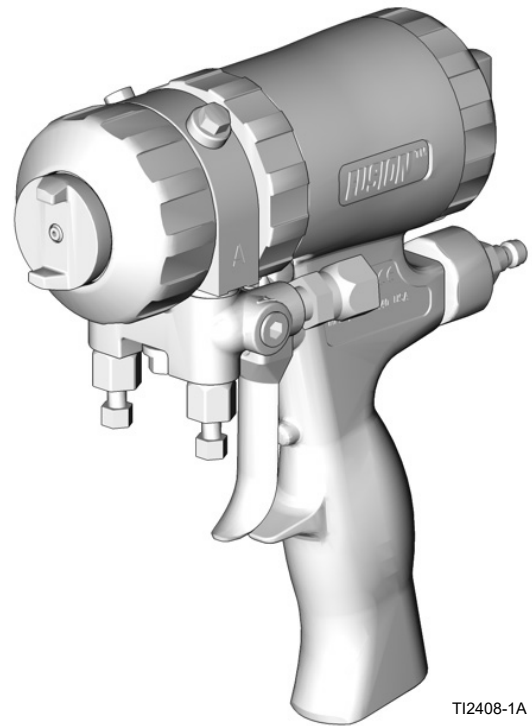

T12408-1A

Contents

| | | | |
|---|-----------|---|-----------|
| Related Manuals | 3 | Clean Fluid Manifold | 27 |
| Models | 4 | Clean Passages | 27 |
| Round Pattern Guns | 4 | Clean Muffler | 27 |
| Flat Pattern Guns | 5 | Inspect the Piston | 28 |
| Flat Pattern Stud Wall Gun | 6 | Inspect the Air Valve | 28 |
| Wide Round Pattern Gun | 6 | Remove Front End | 29 |
| Four-Hose Gun | 7 | Attach Front End | 29 |
| Spatter Pattern Gun | 7 | Troubleshooting | 30 |
| Non 1:1 Ratio Guns | 7 | Parts | 33 |
| Warnings | 8 | Detail Views | 35 |
| Important Isocyanate (ISO) Information | 11 | Mix Chamber Kits | 36 |
| Isocyanate Conditions | 11 | Flat Tip Kits | 37 |
| Material Self-Ignition | 12 | Gun Repair Kits | 38 |
| Keep Components A and B Separate | 12 | Check Valve Filter Screen Kits | 38 |
| Moisture Sensitivity of Isocyanates | 12 | Drill Bit Kit | 38 |
| Foam Resins with 245 fa Blowing Agents | 12 | Handle Cleanout Drill Kit | 38 |
| Changing Materials | 12 | Drill Bit Kits | 39 |
| Overview | 13 | Reamer Kits | 40 |
| Theory of Operation | 13 | Accessories | 41 |
| Component Identification | 14 | Fusion PC Conversion Kits | 41 |
| Installation | 15 | Side Seal Kits | 42 |
| Grounding | 15 | Side Seal Cartridge Kits | 42 |
| Setup | 15 | Extension Tip Kits | 42 |
| Optional Configurations | 17 | Extension Tip Seal Kits | 42 |
| Operation | 19 | Extension Tip Air Cap Kit | 42 |
| Pressure Relief Procedure | 19 | Flat Pattern Stud Wall Kit | 42 |
| Piston Safety Lock | 20 | Pour Nozzle Kit | 43 |
| Turn the Air Cap | 20 | Gun Cleaning Kit | 43 |
| Loss of Air Pressure | 20 | Hose Adapter Kits | 43 |
| Flush Gun | 20 | Spatter Conversion Kit | 43 |
| Daily Shutdown | 21 | Gun Cover | 43 |
| Maintenance | 22 | Lubricant for Gun Rebuild | 43 |
| Preventative Maintenance | 22 | Grease Cartridge for Gun Shutdown | 43 |
| Supplied Tool Kit | 22 | Flushing Manifold | 43 |
| Clean Gun Surface | 22 | Adjustable Flow Cap Kit | 43 |
| Clean Mix Chamber Nozzle | 23 | Solvent Flush Canister Kit | 44 |
| Clean Air Cap | 23 | Solvent Flush Pail Kit | 44 |
| Clean Impingement Ports | 23 | Tip Cleanout Tool | 44 |
| Lubrication | 24 | Circulation Manifold | 44 |
| Inspect the Mix Chamber and Side Seal Cartridges | 24 | Technical Specifications | 45 |
| Inspect the Piston Safety Lock | 26 | Air Flow by Mix Chamber | 45 |
| Inspect the Check Valves | 26 | Graco Standard Warranty | 46 |

Related Manuals

| Manual in English | Description |
|--------------------------|--|
| 309963 | Fusion Solvent Flush Kit |
| 309818 | Circulation Manifold Kit |
| 3A5616 | Fusion Adjustable Flow Cap Kit |
| 311071 | Stud Wall Foam Kit and TP100 Kit |
| 3A7314 | Fusion PC Spray Gun Instruction Manual |
| 3A7318 | Fusion PC Conversion Kit |

Models

Round Pattern Guns

| Gun Part, Series | Mix Chamber | | | | |
|------------------|-------------|--------------------------------|-----------------|---------------|---|
| | Part Number | Impingement Port Size in. (mm) | Equivalent Size | Seal Material | Pattern at 24 in (61 cm) from target in. (mm) |
| 246099, A | AR2020 | 0.020 (0.50) | -000 | SST | 5 (127) |
| 246100, A | AR2929 | 0.029 (0.70) | -00 | SST | 8 (203) |
| 248617, A | AR3737 | 0.037 (0.94) | None | SST | 9 (227) |
| 246101, A | AR4242 | 0.042 (1.00) | -01 | SST | 11 (279) |
| 246102, A | AR5252 | 0.052 (1.30) | -02 | SST | 12 (305) |
| 246103, A | AR6060 | 0.060 (1.50) | -03 | SST | 14 (356) |
| 246104, A | AR7070 | 0.070 (1.75) | -04 | SST | 15 (381) |
| 246105, A | AR8686 | 0.086 (2.15) | -05 | SST | 18 (457) |
| 255201, A | AR4242 | 0.042 (1.00) | -01 | Polycarballoy | 11 (279) |
| 255202, A | AR5252 | 0.052 (1.30) | -02 | Polycarballoy | 12 (305) |

Round Pattern Mix Chambers by Pressure and Flow Rate

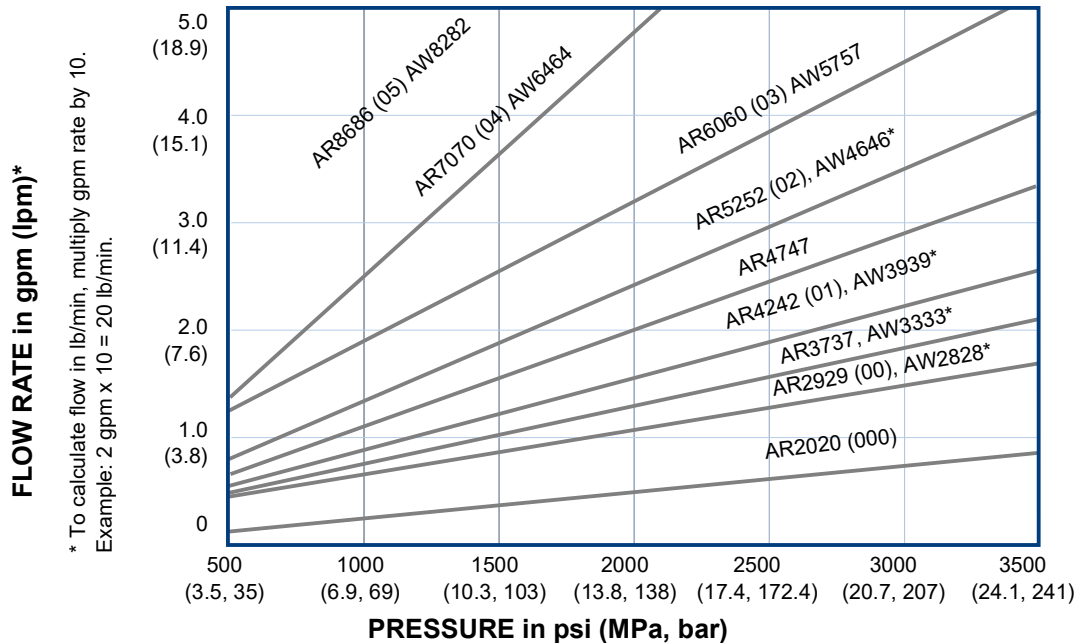

*Accessory AW (wide pattern) mix chambers are available. See **Extension Tip Kits**, page 42.

Flat Pattern Guns

| Gun Part, Series | Mix Chamber | | | Flat Tip | | |
|---------------------|----------------|--------------------------------------|--------------------|----------------|--------------------------|--------------------------|
| | Part Number | Impingement Port Size in. (mm) | Equivalent Size | Part Number | Pattern Size in. (mm) | Orifice Size in. (mm) |
| 247101, A | AF2020 | 0.020 (0.50) | -000 | FT0424 | 8-10 (203-254) | 0.024 (0.61) |
| 247102, A | AF2020 | 0.020 (0.50) | -000 | FT0438 | 8-10 (203-254) | 0.038 (0.97) |
| 247103, A | AF2020 | 0.020 (0.50) | -000 | FT0624 | 12-14 (305-356) | 0.024 (0.61) |
| 247104, A | AF2020 | 0.020 (0.50) | -000 | FT0638 | 12-14 (305-356) | 0.038 (0.97) |
| 247107, A | AF2020 | 0.020 (0.50) | -000 | FT0838 | 16-18 (406-457) | 0.038 (0.97) |
| 247108, A | AF2020 | 0.020 (0.50) | -000 | FT0848 | 16-18 (406-457) | 0.048 (1.22) |
| 247111, A | AF2929 | 0.029 (0.70) | -00 | FT0424 | 8-10 (203-254) | 0.024 (0.61) |
| 247112, A | AF2929 | 0.029 (0.70) | -00 | FT0438 | 8-10 (203-254) | 0.038 (0.97) |
| 247113, A | AF2929 | 0.029 (0.70) | -00 | FT0624 | 12-14 (305-356) | 0.024 (0.61) |
| 247114, A | AF2929 | 0.029 (0.70) | -00 | FT0638 | 12-14 (305-356) | 0.038 (0.97) |
| 247117, A | AF2929 | 0.029 (0.70) | -00 | FT0838 | 16-18 (406-457) | 0.038 (0.97) |
| 247118, A | AF2929 | 0.029 (0.70) | -00 | FT0848 | 16-18 (406-457) | 0.048 (1.22) |
| 247121, A | AF4242 | 0.042 (1.00) | -01 | FT0424 | 8-10 (203-254) | 0.024 (0.61) |
| 247122, A | AF4242 | 0.042 (1.00) | -01 | FT0438 | 8-10 (203-254) | 0.038 (0.97) |
| 247123, A | AF4242 | 0.042 (1.00) | -01 | FT0624 | 12-14 (305-356) | 0.024 (0.61) |
| 247124, A | AF4242 | 0.042 (1.00) | -01 | FT0638 | 12-14 (305-356) | 0.038 (0.97) |
| 247127, A | AF4242 | 0.042 (1.00) | -01 | FT0838 | 16-18 (406-457) | 0.038 (0.97) |
| 247128, A | AF4242 | 0.042 (1.00) | -01 | FT0848 | 16-18 (406-457) | 0.048 (1.22) |
| 247131, A | AF5252 | 0.052 (1.30) | -02 | FT0424 | 8-10 (203-254) | 0.024 (0.61) |
| 247132, A | AF5252 | 0.052 (1.30) | -02 | FT0438 | 8-10 (203-254) | 0.038 (0.97) |
| 247133, A | AF5252 | 0.052 (1.30) | -02 | FT0624 | 12-14 (305-356) | 0.024 (0.61) |
| 247134, A | AF5252 | 0.052 (1.30) | -02 | FT0638 | 12-14 (305-356) | 0.038 (0.97) |
| 247137, A | AF5252 | 0.052 (1.30) | -02 | FT0838 | 16-18 (406-457) | 0.038 (0.97) |
| 247138, A | AF5252 | 0.052 (1.30) | -02 | FT0848 | 16-18 (406-457) | 0.048 (1.22) |

Flat Pattern Mix Chambers by Pressure and Flow Rate

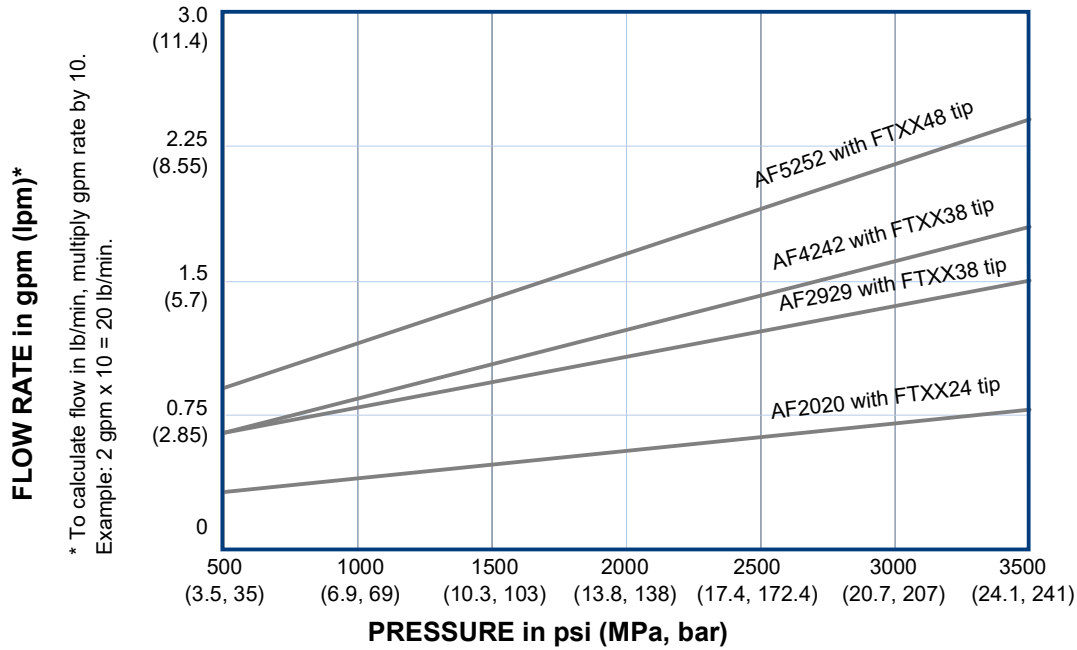

Flat Pattern Stud Wall Gun

Refer to the Stud Wall Foam Kit and TP100 manual for more information. See **Related Manuals**, page 3.

| Gun Part Number | Mix Chamber | | | Flat Tip | | | Flow Data |
|-----------------|-------------|--------------------------------|-----------------|-------------|--|-----------------------|---|
| | Part Number | Impingement Port Size in. (mm) | Equivalent Size | Part Number | Pattern Diameter at 24 in. (610 mm) to Target in. (mm) | Orifice Size in. (mm) | Approximate Flow Rate at 1000 psi (7.0 MPa, 70 bar) |
| 249525 | AF4242 | 0.042 (1.00) | -01 | FTM979 | 22 (559) | 0.038 (0.97) | 11 lb/min (4.99 kg/min) |
| 249526 | AF5252 | 0.052 (1.30) | -02 | FTM979 | 22 (559) | 0.038 (0.97) | 15 lb/min (6.81 kg/min) |

Wide Round Pattern Gun

| Gun Part Number | Mix Chamber | | | Pattern Diameter at 24 in. (610 mm) to Target in. (mm) | Reference Part Number with Equivalent Flow |
|-----------------|-------------|--------------------------------|-----------------|--|--|
| | Part Number | Impingement Port Size in. (mm) | Equivalent Size | | |
| 249529 | AW3939 | 0.039 (0.99) | -01 | 16 (406.4) | AR4242 |
| 249530 | AW4646 | 0.046 (1.17) | -02 | 18 (457.2) | AR5252 |

Four-Hose Gun

Wide Round Pattern Gun with Four-Hose Recirculating Gun Manifold

| Gun Part Number | Mix Chamber | | | Pattern Diameter at 24 in. (610 mm) to Target in. (mm) | Approximate Flow Rate at 1000 psi (7.0 MPa, 70 bar) |
|-----------------|-------------|--------------------------------|---------------------|--|---|
| | Part Number | Impingement Port Size in. (mm) | Equivalent Size | | |
| 249810 | AW2222 | 0.022 (0.56) | Not Available (N/A) | 8-9 (203-229) | 4.5 lb/min (204 kg/min) |

Spatter Pattern Gun









| Gun Part Number | Mix Chamber | | |
|-----------------|-------------|--------------------------------|-----------------|
| | Part Number | Impingement Port Size in. (mm) | Equivalent Size |
| 248408 | AR7070 | 0.070 (1.75) | -04 |

Non 1:1 Ratio Guns

| Gun Part Number | Mix Chamber |
|-----------------|-------------|
| 253888 | AR2232 |

Warnings

The following warnings are for the setup, use, grounding, maintenance, and repair of this equipment. The exclamation point symbol alerts you to a general warning and the hazard symbols refer to procedure-specific risks. When these symbols appear in the body of this manual or on warning labels, refer back to these Warnings. Product-specific hazard symbols and warnings not covered in this section may appear throughout the body of this manual where applicable.

|  <h2 style="margin: 0;">WARNING</h2> | |
|---|--|
|  | <p>TOXIC FLUID OR FUMES HAZARD</p> <p>Toxic fluids or fumes can cause serious injury or death if splashed in the eyes or on skin, inhaled or swallowed.</p> <ul style="list-style-type: none"> • Read Safety Data Sheets (SDSs) for handling instructions and to know the specific hazards of the fluids you are using, including the effects of long-term exposure. • When spraying, servicing equipment, or when in the work area, always keep work area well-ventilated and always wear appropriate personal protective equipment. See Personal Protective Equipment warnings in this manual. • Store hazardous fluid in approved containers, and dispose of it according to applicable guidelines. |
|  | <p>PERSONAL PROTECTIVE EQUIPMENT</p> <p>Always wear appropriate personal protective equipment and cover all skin when spraying, servicing equipment, or when in the work area. Protective equipment helps prevent serious injury, including long-term exposure; inhalation of toxic fumes, mists or vapors; allergic reaction; burns; eye injury and hearing loss. This protective equipment includes but is not limited to:</p> <ul style="list-style-type: none"> • A properly fitting respirator, which may include a supplied-air respirator, chemically impermeable gloves, protective clothing and foot coverings as recommended by the fluid manufacturer and local regulatory authority. • Protective eyewear and hearing protection. |
|      | <p>SKIN INJECTION HAZARD</p> <p>High-pressure fluid from dispensing device, hose leaks, or ruptured components will pierce skin. This may look like just a cut, but it is a serious injury that can result in amputation. Get immediate surgical treatment.</p> <ul style="list-style-type: none"> • Engage piston safety lock when not spraying. • Do not point gun at anyone or at any part of the body. • Do not put your hand over the spray tip. • Do not stop or deflect leaks with your hand, body, glove, or rag. • Follow the Pressure Relief Procedure when you stop spraying and before cleaning, checking, or servicing equipment. • Tighten all fluid connections before operating the equipment. • Check hoses and couplings daily. Replace worn or damaged parts immediately. |

WARNING



BURN HAZARD

Equipment surfaces and fluid that is heated can become very hot during operation. To avoid severe burns:

- Do not touch hot fluid or equipment.



FIRE AND EXPLOSION HAZARD

Flammable fumes, such as solvent and paint fumes, in **work area** can ignite or explode. Paint or solvent flowing through the equipment can cause static sparking. To help prevent fire and explosion:



- Use equipment only in well-ventilated area.
- Eliminate all ignition sources; such as pilot lights, cigarettes, portable electric lamps, and plastic drop cloths (potential static sparking).
- Ground all equipment in the work area. See **Grounding** instructions.
- Never spray or flush solvent at high pressure.
- Keep work area free of debris, including solvent, rags and gasoline.
- Do not plug or unplug power cords, or turn power or light switches on or off when flammable fumes are present.
- Use only grounded hoses.
- Hold gun firmly to side of grounded pail when triggering into pail. Do not use pail liners unless they are anti-static or conductive.
- **Stop operation immediately** if static sparking occurs or you feel a shock. Do not use equipment until you identify and correct the problem.
- Keep a working fire extinguisher in the work area.

WARNING



EQUIPMENT MISUSE HAZARD

Misuse can cause death or serious injury.

- Do not operate the unit when fatigued or under the influence of drugs or alcohol.
- Do not exceed the maximum working pressure or temperature rating of the lowest rated system component. See **Technical Specifications** in all equipment manuals.
- Use fluids and solvents that are compatible with equipment wetted parts. See **Technical Specifications** in all equipment manuals. Read fluid and solvent manufacturer's warnings. For complete information about your material, request Safety Data Sheets (SDSs) from distributor or retailer.
- Turn off all equipment and follow the **Pressure Relief Procedure** when equipment is not in use.
- Check equipment daily. Repair or replace worn or damaged parts immediately with genuine manufacturer's replacement parts only.
- Do not alter or modify equipment. Alterations or modifications may void agency approvals and create safety hazards.
- Make sure all equipment is rated and approved for the environment in which you are using it.
- Use equipment only for its intended purpose. Call your distributor for information.
- Route hoses and cables away from traffic areas, sharp edges, moving parts, and hot surfaces.
- Do not kink or over bend hoses or use hoses to pull equipment.
- Keep children and animals away from work area.
- Comply with all applicable safety regulations.



PRESSURIZED ALUMINUM PARTS HAZARD

Use of fluids that are incompatible with aluminum in pressurized equipment can cause serious chemical reaction and equipment rupture. Failure to follow this warning can result in death, serious injury, or property damage.

- Do not use 1,1,1-trichloroethane, methylene chloride, other halogenated hydrocarbon solvents or fluids containing such solvents.
- Do not use chlorine bleach.
- Many other fluids may contain chemicals that can react with aluminum. Contact your material supplier for compatibility.

Important Isocyanate (ISO) Information

Isocyanates (ISO) are catalysts used in two component materials.

Isocyanate Conditions

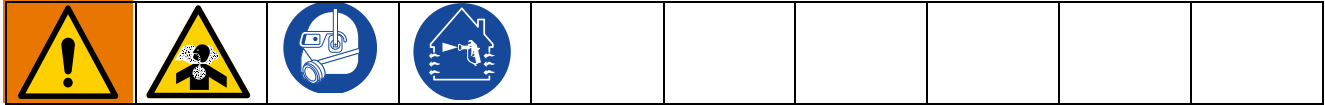



Spraying or dispensing fluids that contain isocyanates creates potentially harmful mists, vapors, and atomized particulates.

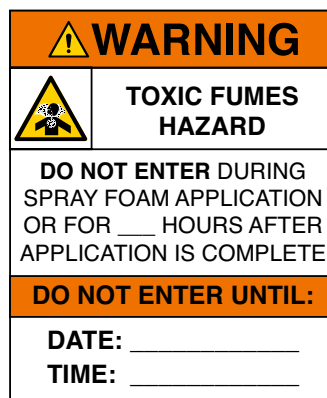

- Read and understand the fluid manufacturer’s warnings and Safety Data Sheets (SDSs) to know specific hazards and precautions related to isocyanates.
- Use of isocyanates involves potentially hazardous procedures. Do not spray with this equipment unless you are trained, qualified, and have read and understood the information in this manual and in the fluid manufacturer’s application instructions and SDSs.
- Use of incorrectly maintained or mis-adjusted equipment may result in improperly cured material, which could cause off gassing and offensive odors. Equipment must be carefully maintained and adjusted according to instructions in the manual.
- To prevent inhalation of isocyanate mists, vapors and atomized particulates, everyone in the work area must wear appropriate respiratory protection. Always wear a properly fitting respirator, which may include a supplied-air respirator. Ventilate the work area according to instructions in the fluid manufacturer’s SDSs.
- Avoid all skin contact with isocyanates. Everyone in the work area must wear chemically impermeable gloves, protective clothing and foot coverings as recommended by the fluid manufacturer and local regulatory authority. Follow all fluid manufacturer recommendations, including those regarding handling of contaminated clothing. After spraying, wash hands and face before eating or drinking.
- Hazard from exposure to isocyanates continues after spraying. Anyone without appropriate personal protective equipment must stay out of the work area during application and after application for the time period specified by the fluid manufacturer. Generally this time period is at least 24 hours.
- Warn others who may enter work area of hazard from exposure to isocyanates. Follow the recommendations of the fluid manufacturer and local regulatory authority. Posting a placard such as the following outside the work area is recommended:



Material Self-Ignition

| | | | | |
|--|---|--|--|--|
|  |  | | | |
| Some materials may become self-igniting if applied too thick. Read material manufacturer's warnings and Safety Data Sheets (SDSs). | | | | |

Keep Components A and B Separate

| | | | | |
|--|---|---|--|--|
|  |  |  | | |
| Cross-contamination can result in cured material in fluid lines which could cause serious injury or damage equipment. To prevent cross-contamination: | | | | |
| <ul style="list-style-type: none"> • Never interchange component A and component B wetted parts. • Never use solvent on one side if it has been contaminated from the other side. | | | | |

Moisture Sensitivity of Isocyanates

Exposure to moisture (such as humidity) will cause ISO to partially cure, forming small, hard, abrasive crystal that become suspended in the fluid. Eventually a film will form on the surface and the ISO will begin to gel, increasing in viscosity.

| NOTICE | |
|--|--|
| Partially cured ISO will reduce performance and the life of all wetted parts. | |
| <ul style="list-style-type: none"> • Always use a sealed container with a desiccant dryer in the vent, or a nitrogen atmosphere. Never store ISO in an open container. • Keep the ISO pump wet cup or reservoir (if installed) filled with appropriate lubricant. The lubricant creates a barrier between the ISO and the atmosphere. • Use only moisture-proof hoses compatible with ISO. • Never use reclaimed solvents, which may contain moisture. Always keep solvent containers closed when not in use. • Always lubricate threaded parts with an appropriate lubricant when reassembling. | |

NOTE: The amount of film formation and rate of crystallization varies depending on the blend of ISO, the humidity, and the temperature.

Foam Resins with 245 fa Blowing Agents

Some foam blowing agents will froth at temperatures above 90°F (33°C) when not under pressure, especially if agitated. To reduce frothing, minimize preheating in a circulation system.

Changing Materials

| NOTICE | |
|---|--|
| Changing the material types used in your equipment requires special attention to avoid equipment damage and downtime. | |
| <ul style="list-style-type: none"> • When changing materials, flush the equipment multiple times to ensure it is thoroughly clean. • Always clean the fluid inlet strainers after flushing. • Check with your material manufacturer for chemical compatibility. • When changing between epoxies and urethanes or polyureas, disassemble and clean all fluid components and change hoses. Epoxies often have amines on the B (hardener) side. Polyureas often have amines on the B (resin) side. | |

Overview

Theory of Operation

Gun Triggered (Fluid Spraying)

Mix chamber (19) moves back, shutting off purge air flow. Impingement ports (IP) align with fluid ports of side seals (18c), allowing fluid to flow through mix chamber nozzle (N).

Key

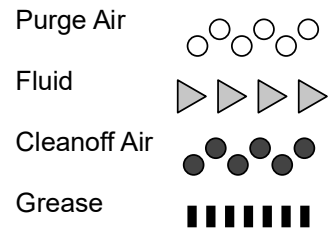

NOTE: Flow paths are not shown to scale.

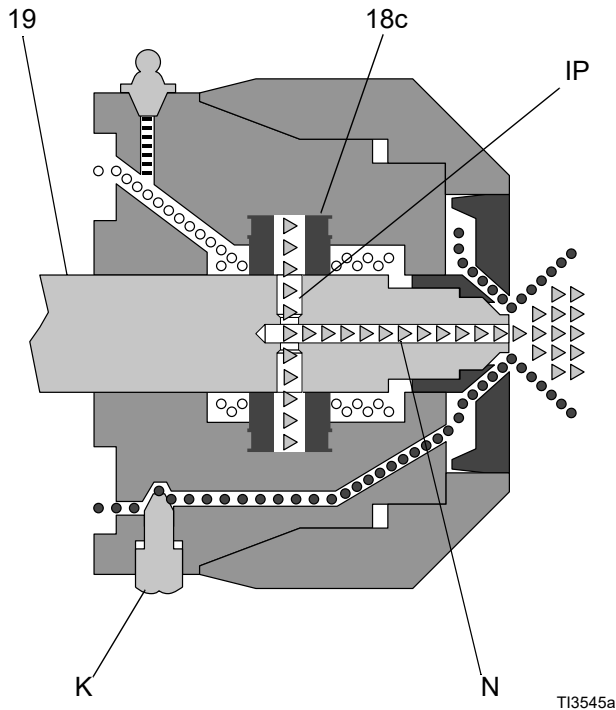

Gun Detriggered (Air Purging)

Mix chamber (19) moves forward, shutting off fluid flow. Impingement ports (IP) open to air chamber (AC), allowing purge air to flow through mix chamber nozzle (N).

Key

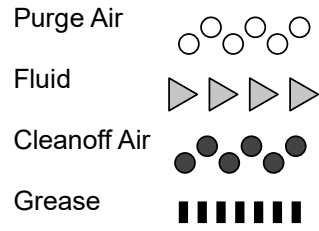

NOTE: Flow paths are not shown to scale.

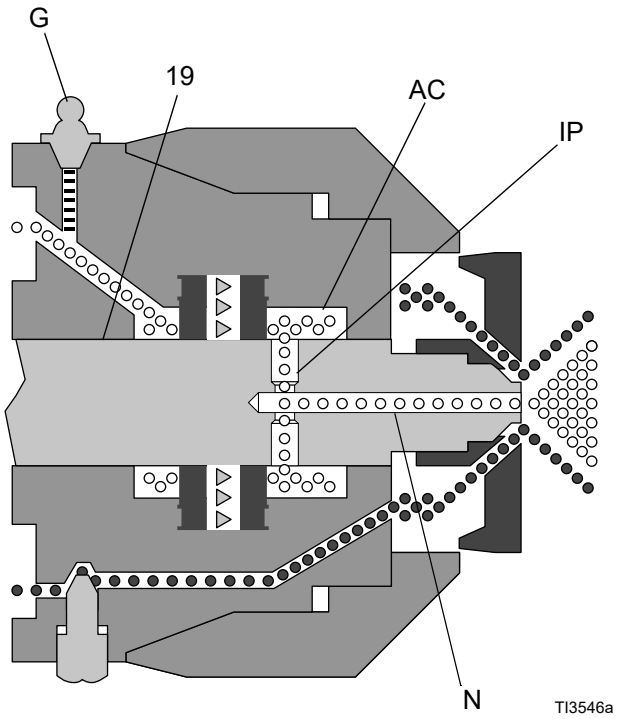

Component Identification

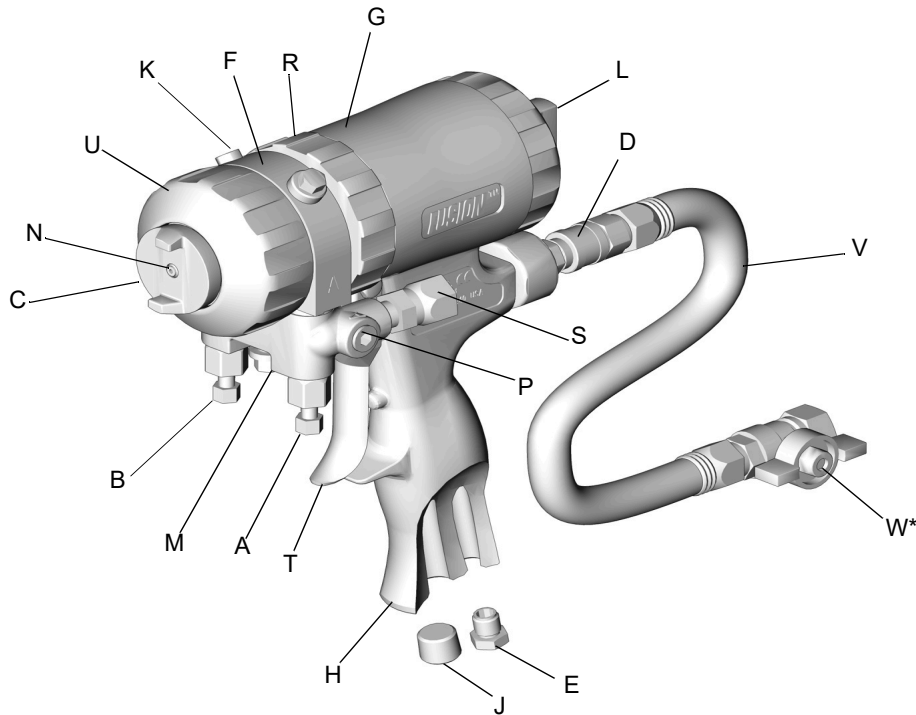

T12408A

FIG. 1: Component Identification

Key

- A A Side Fluid Valve (ISO)
- B B Side Fluid Valve (RESIN)
- C Air Cap
- D Air Line Quick Coupler
- E Muffer
- F Fluid Housing
- G Grease Fitting (under cap)
- H Handle
- J Optional Air Inlet
- K Cleanoff Air Valve
- L Piston Safety Lock



Key

- M Gun Fluid Manifold
- N Mix Chamber Nozzle
- P Optional Fluid Inlets (A Side Shown)
- R Lock Ring
- S Fluid Inlet Swivels (A Side Shown)
- T Trigger
- U Front Retaining Ring
- V Gun Air Whip Hose
- W* Air Valve

* Air Valve (W) is not included with spatter pattern spray gun.

Installation

Grounding

| | | | | |
|--|---|---|--|--|
|  |  |  | | |
| <p>The equipment must be grounded to reduce the risk of static sparking. Static sparking can cause fumes to ignite or explode. Grounding provides an escape wire for the electric current.</p> | | | | |

Spray gun: Ground through connection to a properly grounded fluid hose and pump.

Proportioner: Follow the instructions in your proportioner manual.

Setup

1. Close fluid valves A and B.



2. Connect A (ISO) and B (RESIN) fluid hoses to fluid manifold.

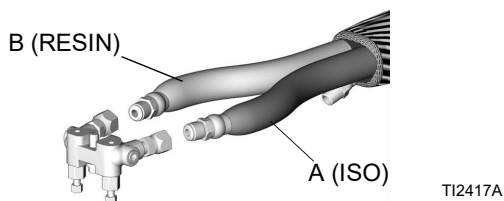

3. Engage piston safety lock (L). See **Piston Safety Lock**, page 20.

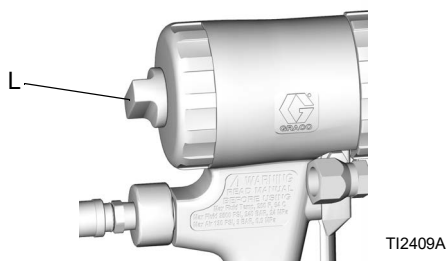

4. Connect gun air whip hose (V) and air valve (W*) to main air hose. Attach fluid manifold (M) to gun.

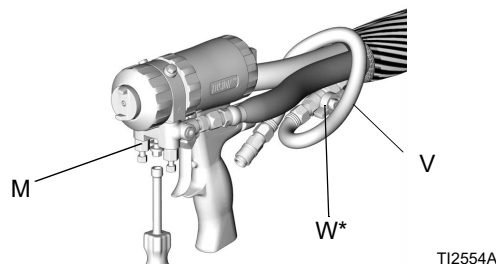

* Air Valve (W) is not included with spatter pattern spray gun.

5. Connect air line quick coupler (D). Turn on air. Open air valve (W*). Air should flow from nozzle (N).

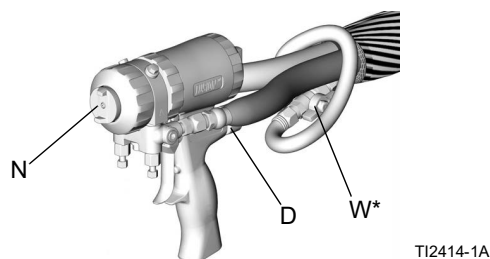

6. Disengage piston safety lock (L). See **Piston Safety Lock**, page 20.

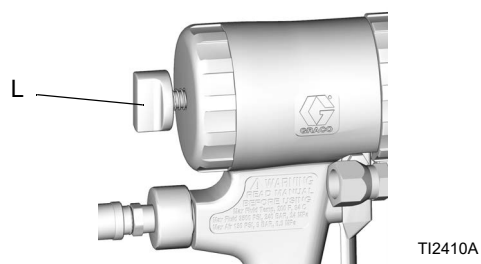

7. Trigger gun to check for full mix chamber travel. Front of air cap (C) should be approximately flush with front retaining ring (U).

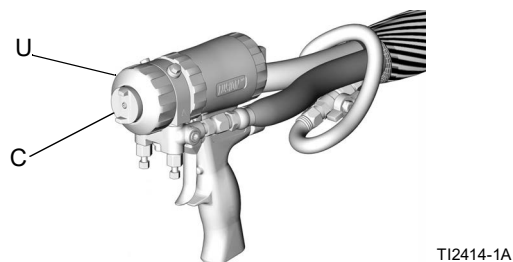

Installation

8. Open cleanoff air valve (K) 1/4-1/2 turn and trigger gun to check that cleanoff air is flowing. Adjust as desired. This step does not apply with spatter pattern spray gun 248408.

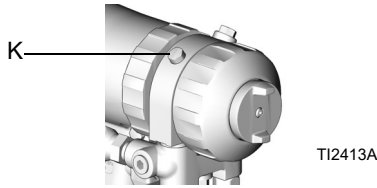

9. Engage piston safety lock (L). See **Piston Safety Lock**, page 20.



10. Turn on proportioner.

11. Open B (RESIN) fluid valve (about three half turns). Then open A (ISO) fluid valve.

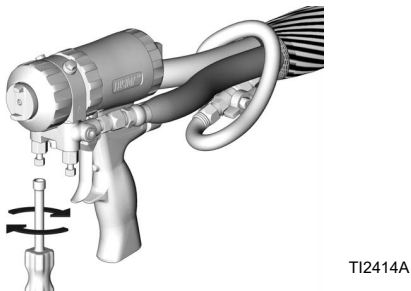

12. Disengage piston safety lock (L). See **Piston Safety Lock**, page 20.

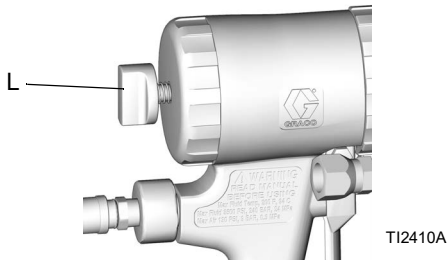

13. Test spray onto cardboard. Adjust pressure and temperature to get desired results.

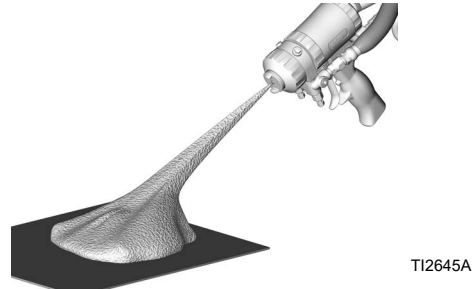

14. Apply layer of lubricant over front of gun and lock ring (R), or use gun cover to prevent overspray buildup and aid disassembly. See **Lubricant for Gun Rebuild**, page 43, to order lubricant and gun cover.

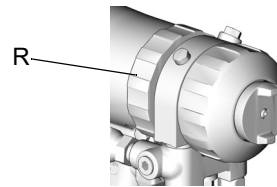

15. Gun is ready to spray.

Optional Configurations

Change Fluid Manifold Position

The fluid manifold is mounted to bottom of gun, with A side on left, viewed from operator's position at back of gun. If desired, manifold may be moved to top of gun. Doing this will reposition A side parts (fluid inlet swivel, check valve, side seal cartridge, and mix chamber) to the right.

NOTICE

To prevent cross-contamination in the gun, do not interchange A component (isocyanate) and B component (resin) parts. Cross-contamination can result in cured material in the gun. Cured material may damage the sealing surfaces, block fluid passages, and prevent gun function.

1. Follow the **Pressure Relief Procedure**, page 19.
2. Disconnect air line quick coupler (D) and remove fluid manifold (M).

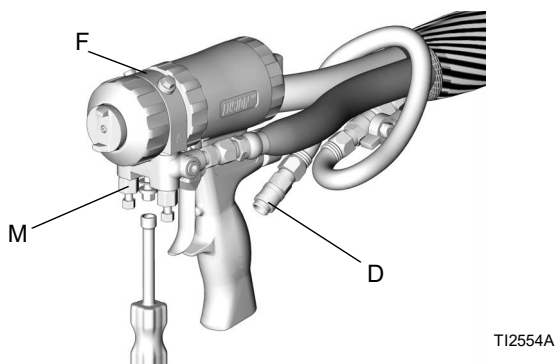

3. Follow the **Remove Front End** procedure, page 29.
4. Rotate the fluid housing (F) 180 degrees.
5. Follow the **Attach Front End** procedure, page 29.
6. Reattach fluid manifold. Reconnect air line. Return gun to service.

Change Hose Position

The fluid inlet swivels and air quick disconnect fitting point to the rear of the gun. If desired, these positions can be changed so hoses travel downward.

NOTICE

To prevent cross-contamination in the gun, do not interchange A component (isocyanate) and B component (resin) parts. Cross-contamination can result in cured material in the gun. Cured material may damage the sealing surfaces, block fluid passages, and prevent gun function.

1. Follow the **Pressure Relief Procedure**, page 19.
2. Relieve the system pressure. Follow the **Pressure Relief Procedure** in your proportioner manual.
3. Disconnect air line (D) and remove fluid manifold (M).

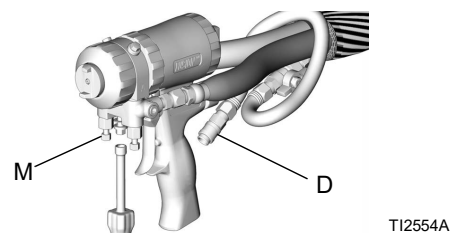

4. Disconnect fluid hoses from fluid inlet swivels (S). Remove swivels. Remove plugs from optional inlets (P).

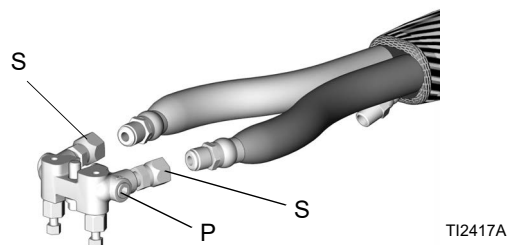

Installation

- Apply thread sealant to plugs (12c), elbows (50*), and male threads of fluid inlet swivels (S). Install elbows (50*) in optional fluid inlets (P), facing down. Install swivels (S) in elbows. Be sure to install A swivel (smaller) in A side. Install included plugs where swivels were located. Torque all parts to 235-245 in-lb (26.6-27.7 N•m).

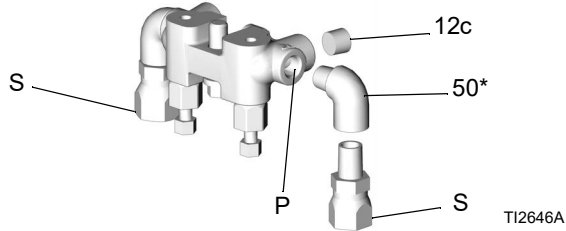

* Elbows (50) are not included with spatter spray gun.

- Connect A and B hoses to A and B swivels.
- Remove air line quick coupler (D) and optional air inlet plug (J). Reverse positions. Apply thread sealant and torque to 125-135 in-lb (14-15 N•m).

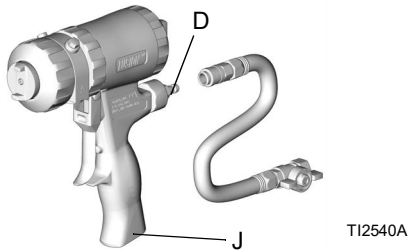

- Reattach fluid manifold. Reconnect air. Return gun to service.

Reposition or Replace Flat Spray Tips

- Follow the **Pressure Relief Procedure**, page 19.
- Remove air cap (10) and flat spray tip (39). Inspect o-ring (40).

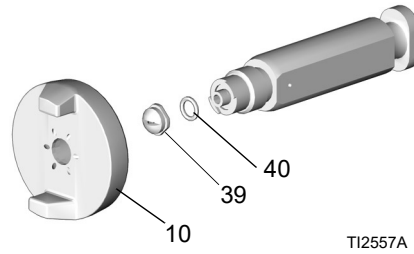

NOTE: If tip is stuck, pry off with small screwdriver or pull off with pliers. Tip is hardened to resist damage.

- To clean, soak tip in compatible solvent, see **Supplied Tool Kit**, page 22. Clean gently with tip cleanout tool 15D234. Refer to **Tip Cleanout Tool**, page 44, to fit tip configuration.
- Reposition tip horizontally or vertically, or install different tip size.

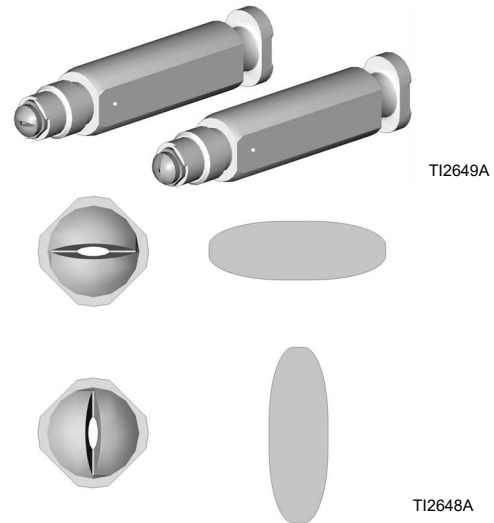

NOTE: Tips marked on back with the last three digits of the part number. See **Flat Tip Part Reference Guide**, page 37.

- Reinstall air cap hand tight.

NOTE: The alignment of the clean off air ports on the air cap does not affect operation.

Operation

Pressure Relief Procedure

 Follow the Pressure Relief Procedure whenever you see this symbol.



This equipment stays pressurized until pressure is manually relieved. To help prevent serious injury from pressurized fluid, such as skin injection, and splashing fluid, follow the **Pressure Relief Procedure** when you stop spraying and before cleaning, checking, or servicing the equipment.

1. Engage the piston safety lock (L). See **Piston Safety Lock**, page 20.

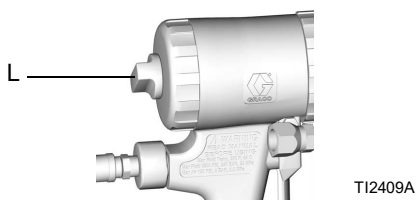

2. Close fluid valves A and B. Leave air valve (W) open.

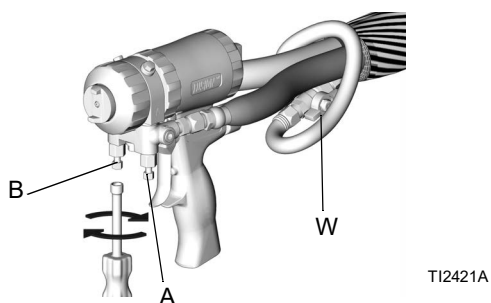

3. Disengage the piston safety lock (L). See **Piston Safety Lock**, page 20.



4. Trigger the gun onto cardboard or into a waste container to relieve pressure.

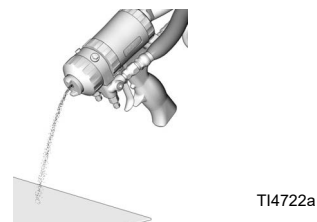

5. Engage the piston safety lock (L). See **Piston Safety Lock**, page 20.

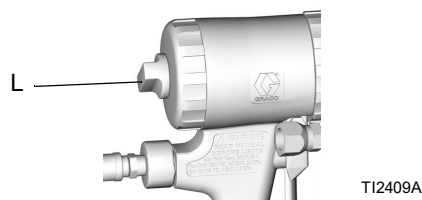

NOTE: After the pressure in the spray gun is relieved, the fluid in the hose and proportioner remains under pressure. Follow the **Pressure Relief Procedure** in your proportioner manual to relieve pressure in the system.

Piston Safety Lock

| | | | | |
|--|--|--|--|--|
| | | | | |
|--|--|--|--|--|

High-pressure fluid from dispensing devices can pierce skin. To help prevent serious injury from pressurized fluid, always engage the piston safety lock and close the material shutoff valves to avoid accidental triggering whenever you stop spraying.

To engage the piston safety lock: Push knob in and turn clockwise. If engaged, gun will not actuate.

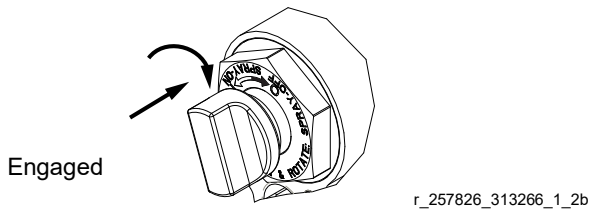

To disengage the piston safety lock: Push knob in and turn counterclockwise until it pops out. There will be a gap between knob and gun body.

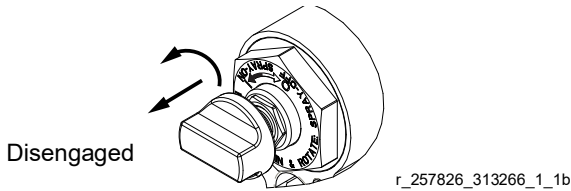

Turn the Air Cap

| | | | | |
|--|--|--|--|--|
| | | | | |
|--|--|--|--|--|

Always follow the **Pressure Relief Procedure**, page 19, before turning the air cap (C).

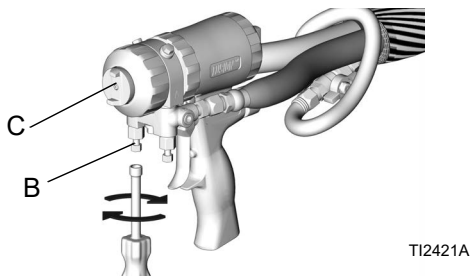

Loss of Air Pressure

In event of loss of air pressure, gun will continue to spray. To shut off gun, do one of the following:

- Engage the piston safety lock. See **Piston Safety Lock**.
- Close fluid valves A and B.

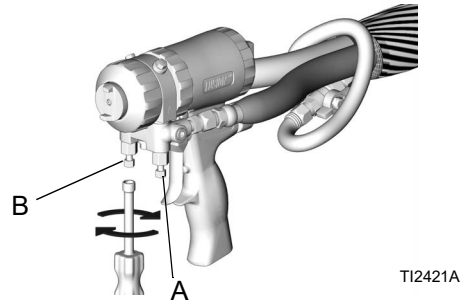

Flush Gun

| | | | | |
|--|--|--|--|--|
| | | | | |
| | | | | |

To avoid fire and explosion, always ground equipment and waste container. To avoid static sparking and injury from splashing, always flush at the lowest possible pressure.

- Follow the **Pressure Relief Procedure**, page 19.
- Disconnect the gun from the hose.
- Connect the gun to the flush manifold block (52).
- Flush with compatible solvent into a grounded metal pail, holding a part of fluid manifold (M) firmly to side of pail. Use the lowest possible fluid pressure when flushing.
- Follow the **Pressure Relief Procedure**, page 19.
- Disconnect the gun from the flush manifold block.

NOTE: For a more thorough flush, Solvent Flush Kits 248139 and 248229 are available as an accessory. The kits connect to Flush Manifold 15B817. See your Solvent Flush Kit manual for detailed flushing instructions.

Daily Shutdown



Grease your gun daily to prevent two component curing and keep fluid passages clean. Purge air carries grease mist through the air chamber (AC) and impingement ports (IP) and out the mix chamber nozzle (N), coating all interior surfaces.

Key

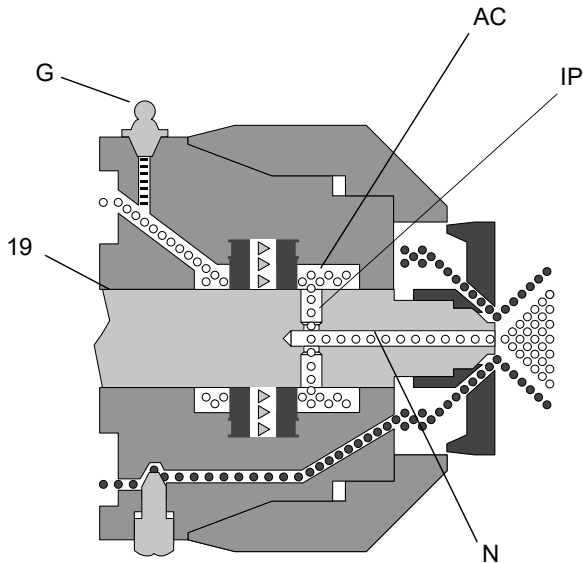
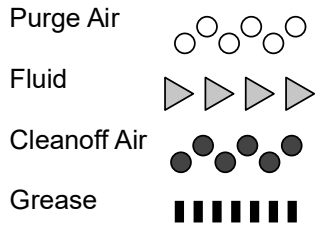

1. Follow the **Pressure Relief Procedure**, page 19.
2. Leave the air turned on and gun detriggered.
3. Remove the grease fitting cap. Using the grease gun (Y), dispense grease into fitting (G) until grease mist sprays from mix chamber nozzle (N).

NOTE: Do not over-grease. Use two shots maximum. Do not spray grease mist on sprayed material.

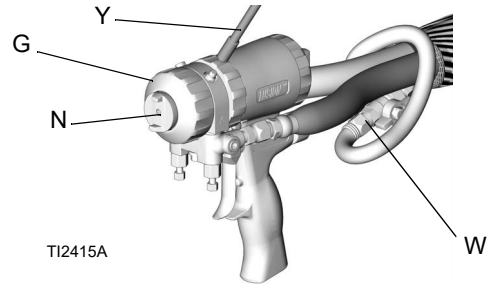

4. Replace the grease cap.
5. **Round and flat pattern guns only:** Turn off the air valve (W).
Spatter pattern gun only: Shut down the main air supply.

Maintenance

Preventative Maintenance

| Recommended Schedule | Maintenance Procedure |
|----------------------|---|
| Daily | Flush Gun , page 20. |
| | Clean Mix Chamber Nozzle , page 23. |
| | Clean Air Cap , page 23 |
| Weekly | Inspect the Mix Chamber and Side Seal Cartridges , page 24. Check o-rings. |
| | Inspect the Check Valves , page 26. Check o-rings and filters. |
| | Inspect the Piston Safety Lock , page 26. |
| | Inspect the Check Valves , page 26. |
| As Needed | Clean Impingement Ports , page 23. |
| | Lubrication , page 24 |

Supplied Tool Kit

- Hex nut driver, 5/16
- Screwdriver, 1/8 blade
- Nozzle drill bit. Various sizes depending on nozzle size.
- Impingement port drill bit, various sizes depending on port size. See TABLE 1, page 23.
- 117661 pin vise, dual reversible chucks

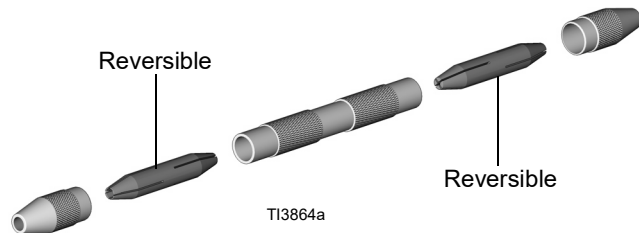

- 551189 grease gun, with 3 oz grease
- 15B817 flush manifold (not included with spatter spray gun).

Clean Gun Surface

Keep gun clean with accessory gun cover.

Applying a light coat of lubricant will make cleaning easier.

Wipe off outside of gun with compatible solvent.

Use N Methyl Pyrrolidone (NMP), Dynaloy[®]-brand Dynasolve CU-6, SB Versaflex-brand Dzol[®], or equivalent to soften cured material.

Clean Mix Chamber Nozzle

1. Follow the **Pressure Relief Procedure**, page 19.
2. Engage the piston safety lock (L). See **Piston Safety Lock**, page 20.

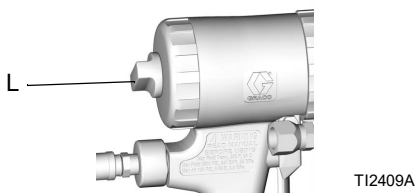

3. Use the appropriate size drill bit to clean mix chamber nozzle (N). If necessary, clean air cap (C) gently with stiff brush.

NOTE: Refer to TABLE 1, and **Drill Bit Kits**, page 39.

| Table 1: Nozzle Drill Bit Sizes | | | |
|--|----------------------------|--------------------------------|----------------------------|
| Round Spray | | Flat Spray | |
| Mix Chamber Part Number | Drill Size in. (mm) | Mix Chamber Part Number | Drill Size in. (mm) |
| AR2020 | #58, 0.042 (1.00) | AF2020 | 3/32, 0.094 (2.35) |
| AR2929 | #55, 0.052 (1.30) | AF2929 | 3/32, 0.094 (2.35) |
| AR3737 | #55, 0.052 (1.30) | | |
| AR4242 | #53, 0.060 (1.50) | AF4242 | 3/32, 0.094 (2.35) |
| AR4747 | 1/16, 0.0625 (1.59) | | |
| AR5252 | #50, 0.070 (1.75) | AF5252 | 3/32, 0.094 (2.35) |
| AR6060 | #44, 0.086 (2.15) | | |
| AR7070 | 3/32, 0.094 (2.35) | | |
| AR8686 | #32, 0.116 (2.90) | | |
| AR2237 | 0.47 (1.2) | AF2033 | 3/32, 0.094 (2.35) |
| AR2924 | #55, 0.052 (1.30) | AF2942 | 3/32, 0.094 (2.35) |
| AR3729 | #55, 0.052 (1.3 mm) | | |

Clean Air Cap

Soak air cap in compatible solvent. Clean holes with #58 (0.042) drill bit.

Clean Impingement Ports

1. Follow the **Pressure Relief Procedure**, page 19.
2. Disconnect air line quick coupler (D) and remove fluid manifold (M).
3. Follow the **Flush Gun** procedure, page 20. If the gun will not flush, see **Inspect the Mix Chamber and Side Seal Cartridges**, page 24.

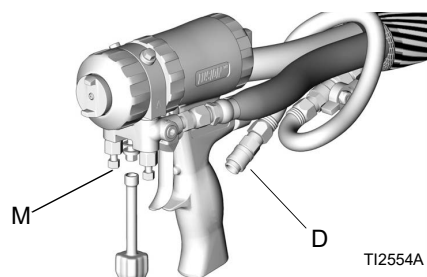

4. Follow the **Remove Front End** procedure, page 29.
5. Push mix chamber (19) forward until impingement ports (IP) are visible. Some mix chambers have counterbored holes (CB) and require two drill sizes to clean impingement ports completely. See TABLE 2, page 24, to select the appropriate drill bit size. Also see **Drill Bit Kits**, page 39.

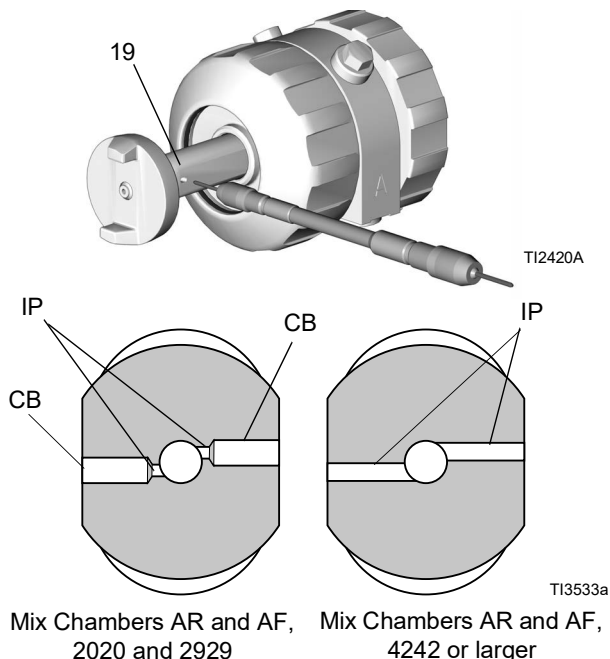

Mix Chambers AR and AF, 2020 and 2929 Mix Chambers AR and AF, 4242 or larger

Table 2: Impingement Port Drill Bit Sizes

| Mix Chamber Part Number | Impingement Port (IP) Drill Bit Size in. (mm) | Counterbore (CB) Drill Bit Size in. (mm) |
|---------------------------------------|---|--|
| AR2020 | #76, 0.020 (0.50) | #53, 0.060 (1.50) |
| AR2929 | #69, 0.029 (0.70) | #53, 0.060 (1.50) |
| AR3737 | #63, 0.037 (0.94) | N/A |
| AR4242 | #58, 0.042 (1.00) | N/A |
| AR4747 | #56, 0.0165 (1.18) | N/A |
| AR5252 | #55, 0.052 (1.30) | N/A |
| AR6060 | #53, 0.060 (1.50) | N/A |
| AR7070 | #50, 0.070 (1.75) | N/A |
| AR8686 | #44, 0.086 (2.15) | N/A |
| AF2020 | #76, 0.020 (0.50) | #53, 0.060 (1.50) |
| AF2929 | #69, 0.029 (0.70) | #53, 0.060 (1.50) |
| AF4242 | #58, 0.042 (1.00) | N/A |
| AF5252 | #55, 0.052 (1.30) | N/A |
| Non 1:1 Ratio Mix Chamber Kits | | |
| AR2232 | #74, 0.023 (0.59) #61, 0.032 (0.81) | #53, 0.060 (1.50) |
| AR2942 | #58, 0.042 (1.07) #69, 0.029 (.74) | #53, 0.060 (1.50) |
| AR3729 | #63, 0.037 (0.94) #69, 0.029 (.74) | #53, 0.060 (1.50) |
| AR2033 | #76, 0.020 (.50) #66, 0.033 (.84) | #53, 0.060 (1.50) |
| AR2942 | #69, 0.029 (.74) #58, 0.042 (1.07) | #53, 0.060 (1.50) |

- Push mix chamber (19) back in position.
- Follow the **Attach Front End** procedure, page 29.
- Reattach fluid manifold (M). Reconnect air. Return gun to service.

Lubrication

Liberaly lubricate all o-rings, seals, and threads. Lubricate threads and outside of lock ring (11). See **Lubricant for Gun Rebuild**, page 43 to order lubricant.

Inspect the Mix Chamber and Side Seal Cartridges

See **Models**, page 4, for available mix chamber sizes.

- Follow the **Pressure Relief Procedure**, page 19.
- Follow the **Flush Gun** procedure, page 20, to remove residual chemical.
- Remove fluid manifold (M). Leave air connected.

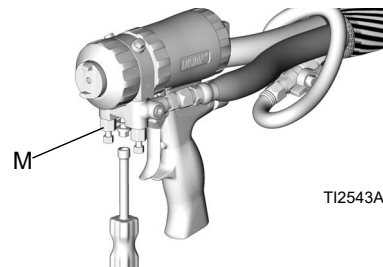

T12543A

- Disconnect gun air whip hose (V) from air line quick coupler (D).

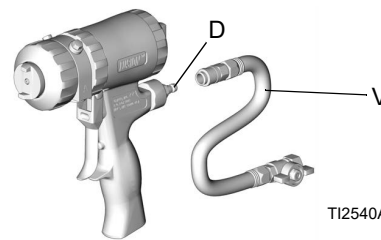

T12540A

- Follow the **Remove Front End** procedure, page 29.
- Remove air cap (10) and retaining ring (9). Inspect o-ring (3) inside retaining ring.

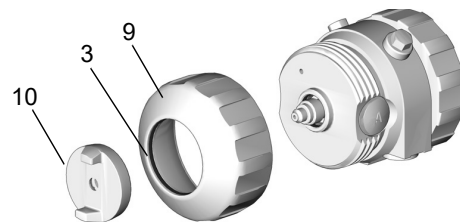

T12424A

- Pull out side seal cartridges (18).

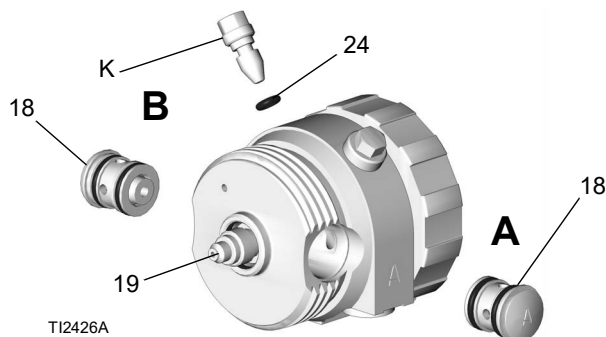

- Pull mix chamber (19) out rear of fluid housing. Inspect for damage. Follow the **Clean Impingement Ports** procedure, page 23.
- Apply thin coat of lubricant to mix chamber (19). Install mix chamber. Etched A and notch (N) must be on same side as A on fluid housing. Mix chamber is keyed to fit in fluid housing.

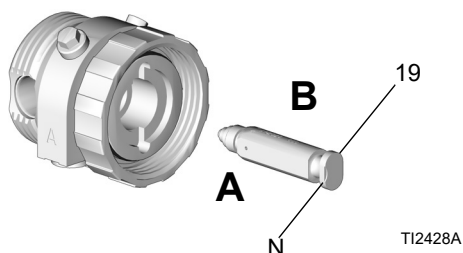

NOTICE

To prevent cross-contamination in the gun, do not interchange A component (isocyanate) and B component (resin) parts. Cross-contamination can result in cured material in the gun. Cured material may damage the sealing surfaces, block fluid passages, and prevent gun function.

- Carefully inspect side seal cartridge o-rings and surfaces. Replace worn or damaged parts. Liberally lubricate o-rings (18d, 18e) and reassemble. Press on side seal (18c) to check proper spring (18b) operation.

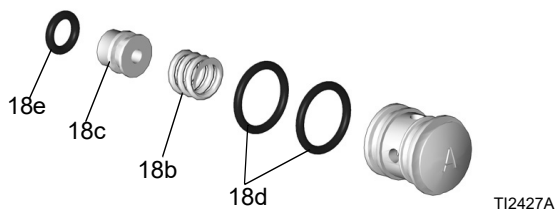

- Lubricate and reinstall side seal cartridges (18).

NOTICE

To prevent cross-contamination in the gun, do not interchange A component (isocyanate) and B component (resin) parts. Cross-contamination can result in cured material in the gun. Cured material may damage the sealing surfaces, block fluid passages, and prevent gun function.

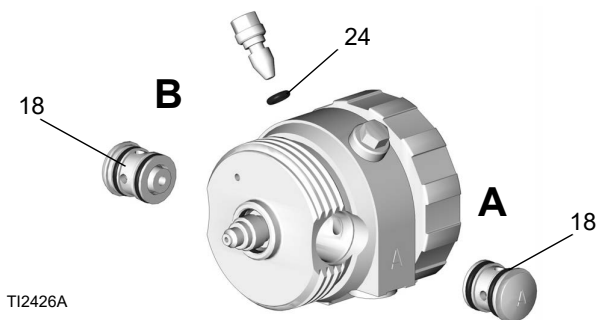

- Lubricate all threads and reinstall retaining ring (9). Install air cap (10).

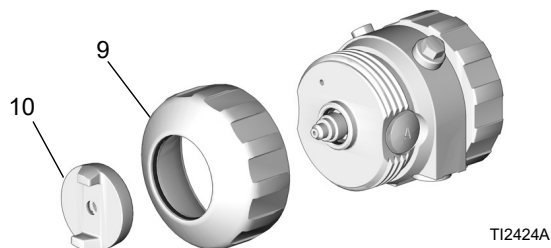

- Follow the **Attach Front End** procedure, page 29.
- Connect air and trigger the gun a few times to check for leaks. If either check valve pops out of its seated position, there is a poor fluid seal on that side of the mix chamber or side seal/cartridge components. Correct the problem before attaching the fluid manifold.
- Attach fluid manifold. Connect air. Return gun to service.

Inspect the Piston Safety Lock

1. Follow the **Pressure Relief Procedure**, page 19.
2. Disconnect air line quick coupler (D) and remove fluid manifold (M).

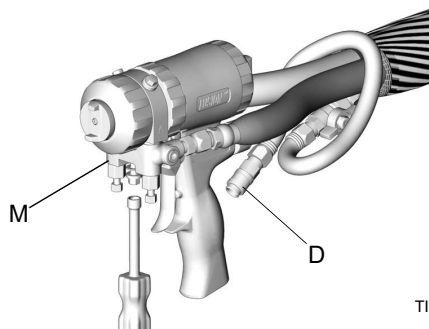

TI2554A

3. Unscrew cylinder cap (5). Hold piston stop (28) with wrench and unscrew from safety lock (4). Inspect spring (30) and o-rings (14, 24).

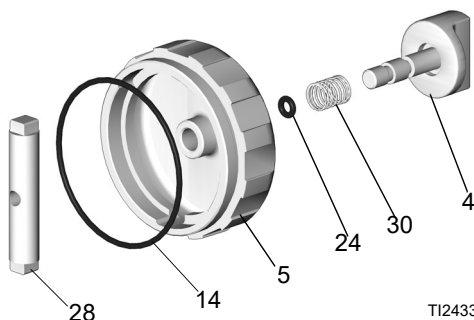

TI2433A

4. Liberally lubricate o-rings and reassemble. Clean threads with solvent or alcohol. Apply medium-strength Loctite® or equivalent to threads on stop (28) and reassemble.
5. Attach fluid manifold.
6. Connect air. Return gun to service.

Inspect the Check Valves

1. Follow the **Pressure Relief Procedure**, page 19.
2. Follow the **Flush Gun** procedure, page 20, to remove residual chemical.
3. Remove fluid manifold (M). Leave air connected.

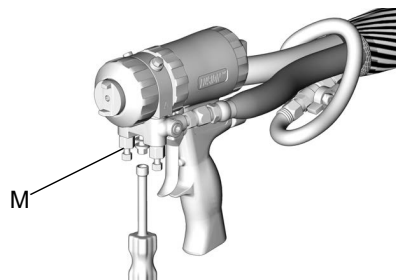

TI2543A

4. Disconnect gun air whip hose (V) from air line quick coupler (D).

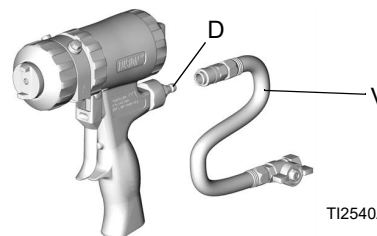

TI2540A

NOTICE

To prevent cross-contamination in the gun, do not interchange A component (isocyanate) and B component (resin) parts. Cross-contamination can result in cured material in the gun. Cured material may damage the sealing surfaces, block fluid passages, and prevent gun function.

5. Pry out check valves (26) at notch.

| | | | | |
|---|--|--|--|--|
| | | | | |
| <p>Damaged check o-rings (26f, 26g) may result in external leakage. To avoid potential leakage and serious injury from skin injection, replace any damaged o-rings.</p> | | | | |

- Slide filter (26d) off. Clean and inspect parts. Thoroughly inspect o-rings (26f, 26g). If necessary, remove screw (26b) and disassemble entire check valve.

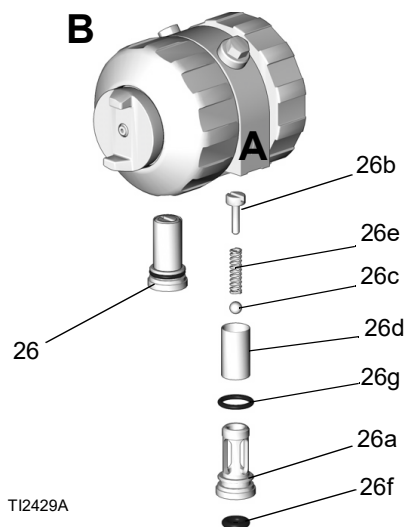

- Reassemble check valves. Screw (26b) should be flush (within 1/16 in. or 1.5 mm) of housing (26a) surface. Liberally lubricate o-rings (26f, 26g) and carefully reinstall in fluid housing.
- Attach fluid manifold. Connect air. Return gun to service.

Clean Fluid Manifold

Clean fluid manifold sealing faces with compatible solvent and a brush whenever removed from gun. Be sure to clean the two fluid ports (FP) in the top mating surface. Do not damage the flat sealing surfaces. Coat with grease if left exposed, to seal out moisture.

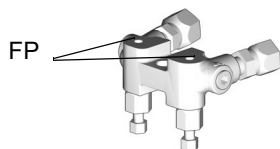

Clean Passages

If necessary, clean out passages in fluid housing and handle with drill bits. Refer to TABLE 3 and to FIG. 2 for diameter and location of passages. All drill bits are available in an accessory kit see **Accessories**, page 41.

| Passage Description | Ref. Letter | Diameter in. (mm) |
|---------------------|-------------|-----------------------|
| Optional Air Inlet | C | 7/16, 1/8 (11.0, 3.1) |
| Purge Air | D | 1/8 (3.1) |
| Piston Air | E, F | 1/8 (3.1) |
| Air Exhaust | G | 11/32, 1/8 (8.7, 3.1) |
| Air Valve Bore | H | 9/32 (7.1) |
| Cleanoff Air | Not Shown | 3/32 (2.35) |
| Check Valve Holes | Not Shown | 3/32 (2.35) |
| Grease | Not Shown | 3/32 (2.35) |

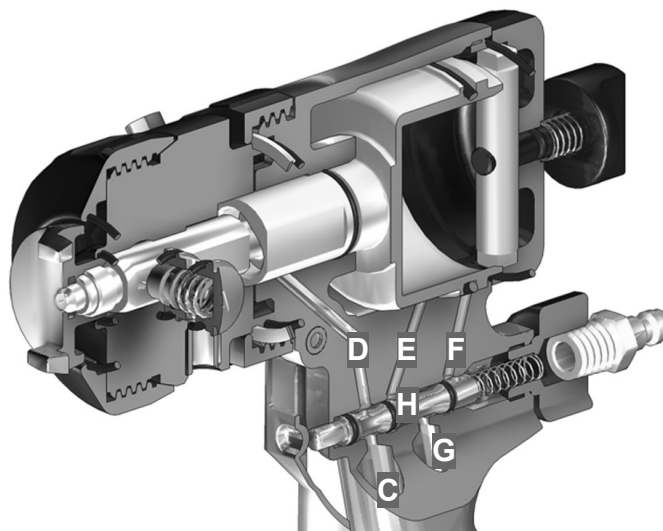

FIG. 2 Gun Passages

Clean Muffler

Remove and clean muffler with compatible solvent.

Inspect the Piston

1. Follow the **Pressure Relief Procedure**, page 19.
2. Disconnect air line (D) and remove fluid manifold (M).

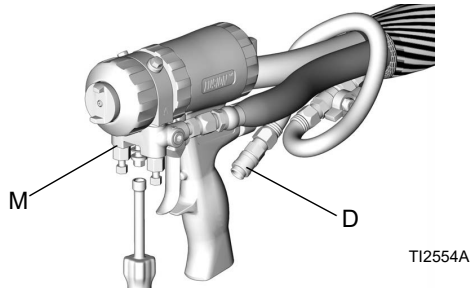

3. Follow the **Remove Front End** procedure, page 29.
4. Unscrew cylinder cap (5) and inspect o-ring (14).

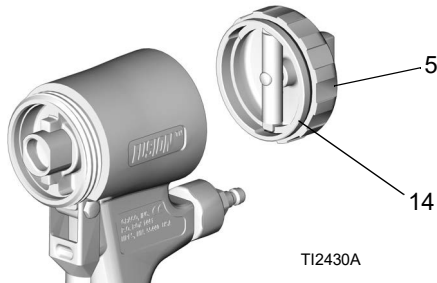

5. Push piston shaft to remove piston (15).
6. Inspect piston o-ring (16) and shaft o-ring (17). Replace o-rings if worn or damaged.

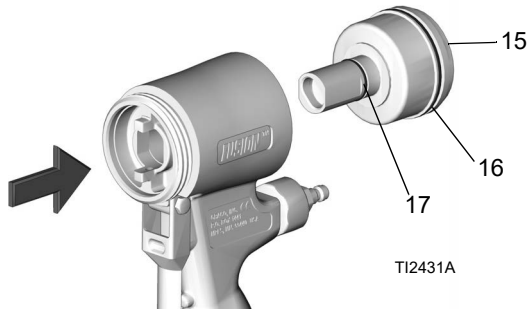

7. Liberally lubricate piston o-rings. Reinstall piston. Shaft is keyed for proper assembly. Push firmly to seat piston.

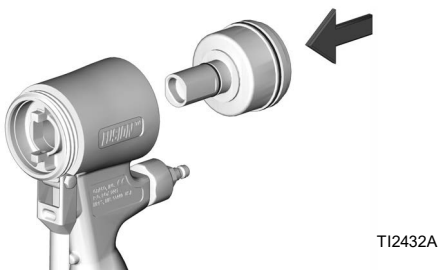

8. Install cylinder cap (5).

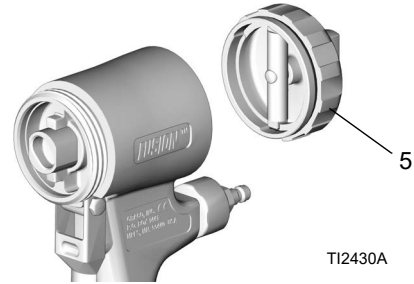

9. Follow the **Attach Front End** procedure, page 29.
10. Attach fluid manifold. Connect air. Return gun to service.

Inspect the Air Valve

1. Follow the **Pressure Relief Procedure**, page 19.
2. Disconnect air line (D) and remove fluid manifold (M).

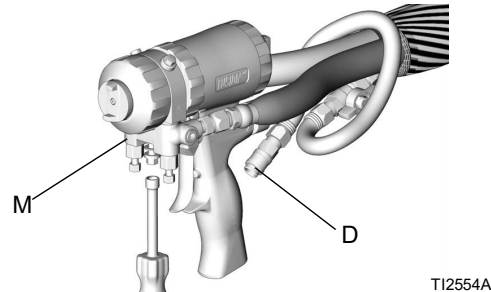

3. Unscrew air valve plug (2) and remove spring (31). Using a small diameter tool, push spool (32) out from front. Inspect o-rings (24).

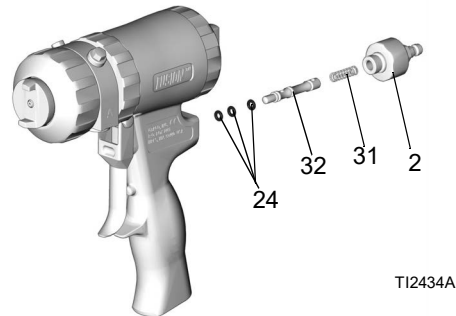

4. Liberally lubricate o-rings and reassemble. Torque plug (2) to 125-135 in-lb (14-15 N•m).
5. Attach fluid manifold.
6. Connect air. Return gun to service.

Remove Front End

1. Follow the **Pressure Relief Procedure**, page 19.
2. Follow the **Flush Gun** procedure, page 20.

NOTICE

If lock ring (R) is stuck due to material buildup, do not force it by turning entire front end. Locating tabs (Z) may break off. Soak front of gun in solvent to soften cured material and free lock ring.

3. Unscrew lock ring (R) until front end of gun is loose. Turn fluid housing (F) 1/8 turn counterclockwise. Unscrew lock ring completely and remove front end of gun.

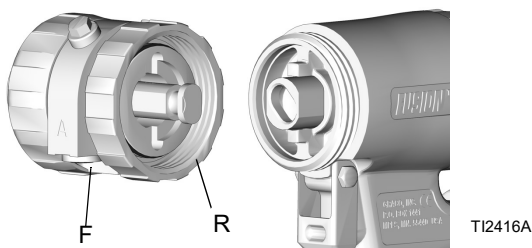

Attach Front End



Improper attachment of the front end may result in serious injury from skin injection. To avoid injury, check that the front end is securely attached and the lock ring is snug against the handle before gun operation.

1. Engage the piston safety lock (L). See **Piston Safety Lock**, page 20.

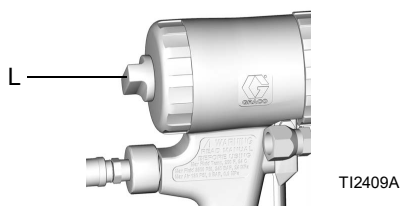

2. Push on air cap (C) until it is flush with front of gun. This ensures that mix chamber is all the way back.

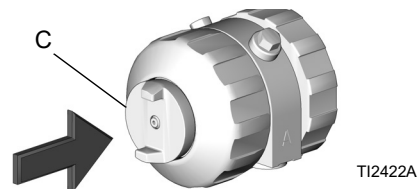

3. Check that o-ring (21) is in position. Liberally lubricate o-ring, threads of lock ring (R) and handle (H), and outside of lock ring. Orient front end (F) as required for desired fluid manifold mounting (bottom mounting is shown).

4. Insert keyed end of mix chamber (19) in socket (X). Screw lock ring onto handle as far as possible by hand.

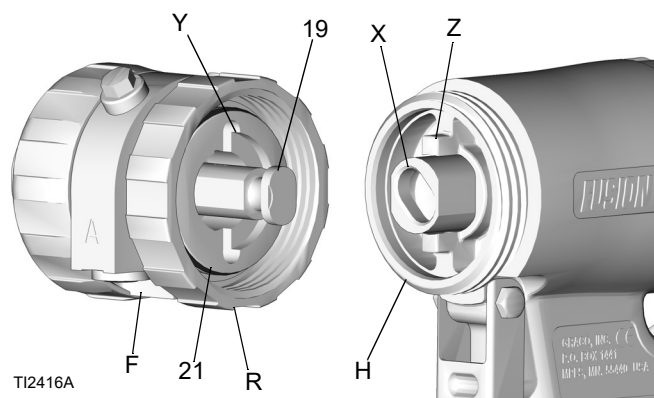

5. Turn fluid housing 1/8 turn clockwise to engage slots (Y) and tabs (Z). Push on front end to ensure it is properly seated. Continue screwing lock ring (R) onto handle (H) very securely. When properly assembled, lock ring is snug against handle.

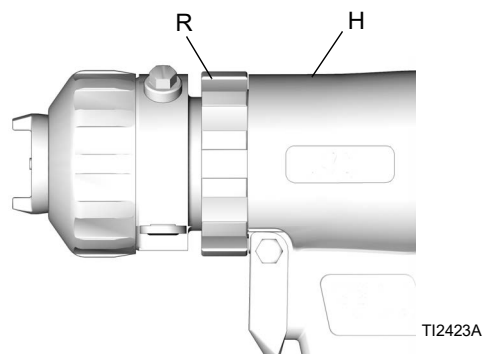

Troubleshooting



1. Follow the **Pressure Relief Procedure**, page 19, before checking or repairing the gun.
2. Check all possible problems and causes before disassembling the gun.

NOTICE

To prevent cross-contamination in the gun, do not interchange A component (isocyanate) and B component (resin) parts. Cross-contamination can result in cured material in the gun. Cured material may damage the sealing surfaces, block fluid passages, and prevent gun function.

| Problem | Cause | Solution |
|---|--|--|
| Gun does not fully actuate when triggered | The safety lock is engaged. | Disengage safety lock. See Piston Safety Lock , page 20. |
| | The muffler is plugged (22). | Clean the muffler. See Clean Muffler , page 27. |
| | The air valve o-rings are damaged (24). | Replace the air valve o-rings. See Inspect the Air Valve , page 28. |
| Fluid does not spray when the gun is fully actuated | The fluid valves are closed (12b). | Open the fluid valves. |
| | The impingement ports are plugged. | Clean the impingement ports. See Clean Impingement Ports , page 23. |
| | The check valves are plugged (26). | Clean the check valves. See Inspect the Check Valves , page 26. |
| Gun actuates slowly | The muffler is plugged (22). | Clean the muffler. See Clean Muffler , page 27. |
| | The piston o-rings are damaged (16, 17). | Replace the piston o-rings. See Parts , page 33. |
| | The air valve is dirty, or the o-rings are damaged (24). | Clean air valve or replace o-rings. See Inspect the Air Valve , page 28. |
| Gun delays, then actuates abruptly | The material around side seals is cured (18). | Inspect side seals (18c) and mix chamber (19) for scratches. Replace. See Inspect the Mix Chamber and Side Seal Cartridges , page 24. |
| | The retaining ring (9) is not bottomed out. | Tighten retaining ring until bottomed out. |
| Loss of round pattern | The mix chamber nozzle is dirty. | Clean the mix chamber nozzle. See Clean Mix Chamber Nozzle , page 23. |

| Problem | Cause | Solution |
|--|---|---|
| Loss of flat pattern | The spray tip is plugged. | Clean in compatible solvent. See Reposition or Replace Flat Spray Tips , page 18. |
| | The tip is worn. | Replace the flat spray tip. See Reposition or Replace Flat Spray Tips , page 18. |
| | The mix chamber nozzle is dirty. | Clean the mix chamber nozzle. See Clean Mix Chamber Nozzle , page 23. |
| Leakage between flat tip and mix chamber | The tip is not seated properly. | Reassemble. See Reposition or Replace Flat Spray Tips , page 18. |
| | The o-ring is damaged or missing (40). | Replace the flat spray tip o-ring. See Reposition or Replace Flat Spray Tips , page 18. |
| Pressure imbalance | The impingement ports are plugged. | Clean the impingement ports. See Clean Impingement Ports , page 23. |
| | The check valves are plugged (26). | Clean the check valves. See Inspect the Check Valves , page 26. |
| | The viscosities not equal. | Adjust temperature to compensate. |
| A and/or B fluid in gun air section | The side seals are damaged (18c). | Replace. See Inspect the Mix Chamber and Side Seal Cartridges , page 24. |
| | The mix chamber is damaged(19). | Replace. See Inspect the Mix Chamber and Side Seal Cartridges , page 24. |
| | The side seal o-rings are damaged (18d, 18e). | Replace the side seal o-rings. See Inspect the Mix Chamber and Side Seal Cartridges , page 24. |
| | The air cap is tightened while the fluid valves (12b) are open. | Close valves first. |
| Fluid mist from mix chamber or air cap | The side seals (18c) are damaged. | Replace the side seals. See Inspect the Mix Chamber and Side Seal Cartridges , page 24. |
| | The side seal o-rings (18d, 18e) are damaged. | Replace the side seal o-rings. See Inspect the Mix Chamber and Side Seal Cartridges , page 24. |
| | The mix chamber (19) is damaged. | Replace the mix chamber. See Inspect the Mix Chamber and Side Seal Cartridges , page 24. |
| Excessive overspray | Too much cleanoff air. | Reduce cleanoff air. See Setup , page 15. |

| Problem | Cause | Solution |
|---|---|---|
| Rapid buildup of material on air cap. | The air cap holes are plugged. | Clean the air cap holes. See Clean Air Cap , page 23. |
| | Too little cleanoff air. | Increase cleanoff air. See Setup , page 15. |
| | The fluid housing o-ring (23) is damaged or missing. | Replace the fluid housing o-ring. See Parts , page 33. |
| | The front o-ring (3) is damaged. | Replace the front o-ring. See Parts , page 33. |
| Reduced cleanoff air. | The front o-ring (3) is damaged. | Replace the front o-ring. See Parts , page 33. |
| Excessive cleanoff air when fluid valves are closed and gun is triggered. | The fluid housing o-ring (23) is damaged or missing. | Replace the fluid housing o-ring. See Parts , page 33. |
| Fluid does not shut off when fluid valves are closed. | The fluid valves (12b) are damaged. | Replace the fluid valves. |
| Burst of air from muffler when gun is triggered. | Normal. | No action required. |
| Steady air leakage from muffler. | The air valve o-rings (24) are damaged. | Replace the valve o-rings. See Inspect the Air Valve , page 28. |
| | The piston o-rings (16, 17) are damaged | Replace the piston o-rings. See Parts , page 33. |
| Air leakage from front air valve. | The air valve o-rings (24) are damaged | Replace the valve o-rings. See Inspect the Air Valve , page 28. |
| Air leak around lock ring. | The o-ring (21) is damaged | Replace the o-ring. See Parts , page 33. |
| Cannot tighten retaining ring (9) until it bottoms out. | The air cap (10) was assembled before retaining ring (9). | Install retaining ring (9) first, then air cap (10). See Inspect the Mix Chamber and Side Seal Cartridges , page 24. |

Parts

NOTE: The round pattern gun is shown below. Refer to **Detail Views**, page 35, for parts specific to other models.

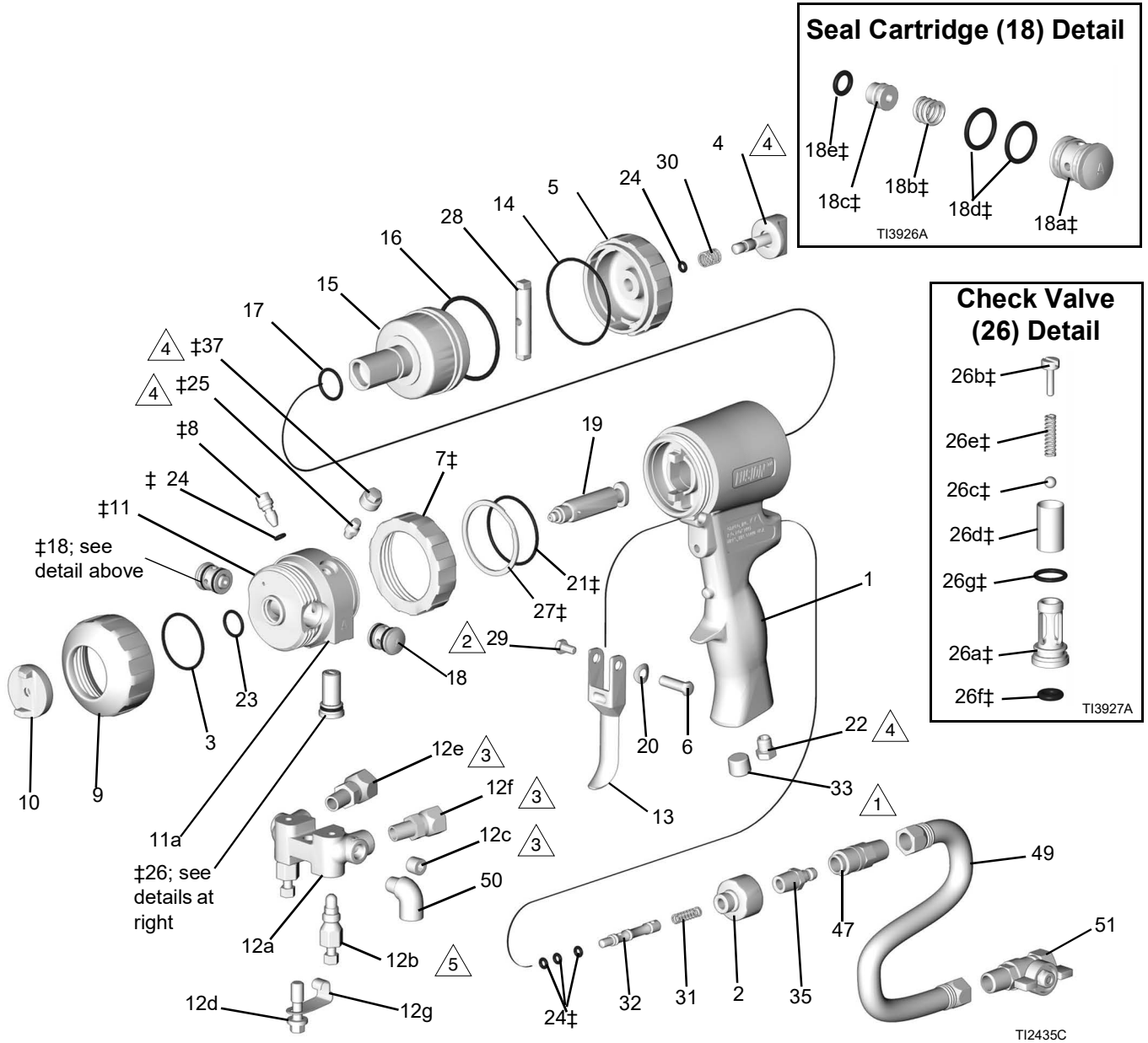

- △1 Torque to 125-135 in-lb (14-15 N•m).
- △2 Torque to 20-30 in-lb (2.3-3.4 N•m).
- △3 Torque to 235-245 in-lb (26.6-27.7 N•m).
- △4 Torque to 35-45 in-lb (4-5 N•m).
- △5 Torque to 32-40 ft-lb (43-54 N•m).

Parts

| Ref. | Part | Description | Qty. | Ref. | Part | Description | Qty. |
|------|--------|--|------|------|--------|---|------|
| 1 | 15K365 | HANDLE | 1 | 26‡ | 246731 | VALVE, check, A side, includes 26a-26g | 1 |
| 2 | 15B208 | PLUG, air valve | 1 | | 246352 | VALVE, check, B side, includes 26a-26g | 1 |
| 3‡ | 248137 | O-RING, PTFE, package of 6 | 1 | 26a‡ | ---- | HOUSING | 1 |
| 4 | 15B206 | LOCK, safety | 1 | 26b‡ | 15B214 | SCREW, 5/16-18 x 1/2 in. (13 mm) | 1 |
| 5 | 15B204 | CAP, cylinder | 1 | 26c‡ | 257420 | BALL; carbide, package of 10 | 1 |
| 6 | 192272 | PIN | 1 | 26d‡ | ---- | SCREEN, see Check Valve Filter Screen Kits , page 38 | 1 |
| 7‡ | 15B215 | RING, lock | 1 | 26e‡ | 117490 | SPRING | 1 |
| 8‡ | 15B223 | VALVE, cleanoff air | 1 | 26f‡ | 248133 | O-RING, check valve face, package of 6 | 1 |
| 9‡ | 15B211 | RING, retaining | 1 | 26g‡ | 248129 | O-RING, check valve housing; package of 6 | 1 |
| 10‡ | 15B210 | AIR CAP, for round pattern guns | 1 | 27‡ | 116550 | RING, retaining | 1 |
| 11‡ | 246491 | HOUSING, fluid | 1 | 28 | 15B205 | STOP, piston | 1 |
| 11a | 248860 | KIT, thread insert, fusion | 1 | 29 | 203953 | SCREW, 10-24 x 3/8 in. (10 mm) | 1 |
| 12 | 246012 | MANIFOLD, fluid, 2-hose, includes 12a-12g | 1 | 30 | 114070 | SPRING | 1 |
| | 249523 | MANIFOLD, fluid, 4-hose, includes 12a, 12b, 12d-12g, 50; see Detail Views , page 35 | 1 | 31 | 117485 | SPRING | 1 |
| 12a | ---- | MANIFOLD | 1 | 32 | 15B202 | SPOOL, valve | 1 |
| 12b | 246356 | VALVE, fluid | 2 | 33 | 100721 | PLUG, pipe, 1/4-18 npt; round and flat pattern guns only | 1 |
| 12c | 100139 | PLUG, pipe; 1/8-27 npt | 2 | 35 | 117509 | QUICK-DISCONNECT, male, air, 1/4 npt(m), round and flat pattern guns only | 1 |
| 12d | 15B221 | BOLT, 5/16-24 | 1 | 36 | 222385 | CARD, warning, not shown | 1 |
| 12e | 117634 | SWIVEL, B side; 1/8 npt(m) x number 6 JIC(f), for 2-hose manifold | 1 | 37‡ | 15B689 | COVER, grease fitting | 1 |
| 12f | 117635 | SWIVEL, A side; 1/8 npt(m) x number 5 JIC(f), for 2-hose manifold | 1 | 46 | 117792 | GREASE GUN, not shown | 1 |
| 12g | 15B993 | SPRING, ring, lock | 1 | 47 | 117510 | COUPLER, air line | 1 |
| 13 | 15B209 | TRIGGER | 1 | 49 | 15B772 | HOSE, air; 1/4 npsm (fbc); 18 in. (0.46 m) | 1 |
| 14 | 248136 | O-RING, cylinder cap, package of 6 | 1 | 50 | 112307 | ELBOW, street; 1/8 npt (m x f), round and flat pattern guns only | 2 |
| 15 | 15B203 | PISTON | 1 | 51 | 15B565 | VALVE, ball, 1/4 npt (m x f), round and flat pattern guns only | 1 |
| 16 | 248135 | O-RING, piston; package of 6 | 1 | 55 | 172479 | TAG, warning, not shown | 1 |
| 17 | 248134 | O-RING, piston shaft; package of 6 | 1 | 56 | 15D235 | SIGN, instruction, not shown | 1 |
| 18‡ | 246349 | CARTRIDGE, seal, A side, SST; includes 18a-18e | 1 | 57 | 117773 | GREASE CARTRIDGE, 3 oz, not show; SDS sheet available at www.graco.com | 1 |
| | 246350 | CARTRIDGE, seal, B side, SST; includes 18a-18e | 1 | 65 | 248279 | GREASE, tube, 4 oz, not shown; SDS sheet available at www.graco.com | 1 |
| 18a | ---- | CARTRIDGE BODY | 1 | | | | |
| 18b | 117491 | SPRING | 1 | | | | |
| 18c | ---- | SEAL KIT, see Side Seal Kits , page 42 | 1 | | | | |
| 18d | 248130 | O-RING, cartridge body; package of 6 | 1 | | | | |
| 18e | 248128 | O-RING, side seal, package of 6 | 1 | | | | |
| 19 | ---- | CHAMBER, mix; see Mix Chamber Kits , page 36 | 1 | | | | |
| 20 | 15C480 | WASHER, wave | 1 | | | | |
| 21‡ | 248132 | O-RING; package of 6 | 1 | | | | |
| 22 | 119626 | MUFFLER | 1 | | | | |
| 23‡ | 248131 | O-RING, package of 6 | 1 | | | | |
| 24‡ | 246354 | O-RING, package of 6 | 1 | | | | |
| 25‡ | 100846 | FITTING, grease | 1 | | | | |

NOTE: See **Detail Views**, page 35, for additional parts.

Replacement safety labels, tags, and cards are available at no cost.



‡ *Included in Front End Replacement Kit 246361.*

For date code B17 or prior, see manual 310767.

Included in Safety Stop Assembly 248064 (includes 1 of item 24).

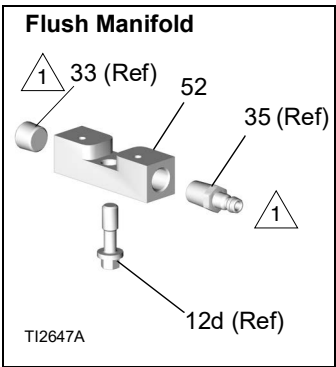
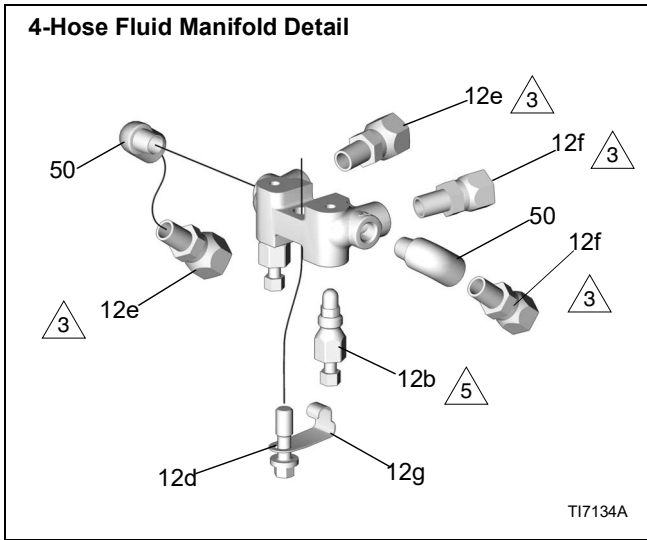
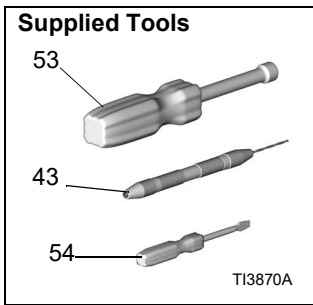
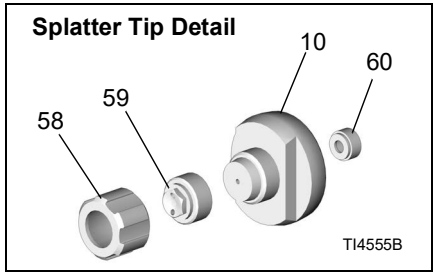
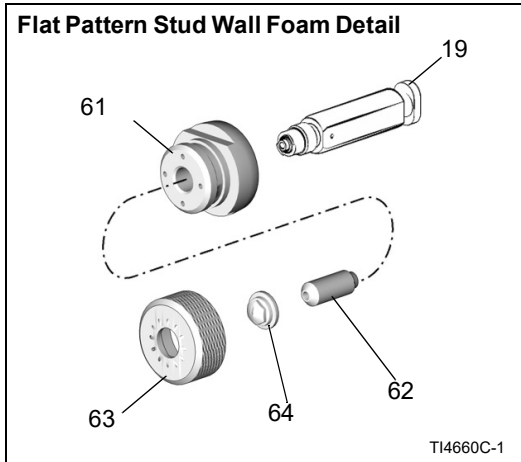
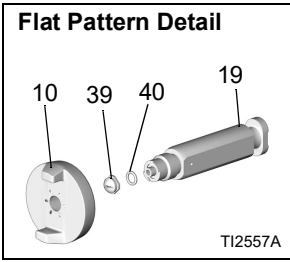
Detail Views



-  Torque to 125-135 in-lb (14-15 N·m).
-  Torque to 235-245 in-lb (26.6-27.7 N·m).
-  Torque to 32-40 ft-lb (43-54 N·m).

| Ref. | Part | Description | Qty. | Ref. | Part | Description | Qty. |
|------|--------|--|------|--------|--|---|------|
| 39 | FTxxxx | TIP, flat, see Flat Tip Kits , page 37 | 1 | 62 | 15F854 | PACKING, tip, stud wall | 1 |
| 40 | 246360 | O-RING, PTFE, flat tip models only; package of 3; see Flat Tip Kits , page 37 | 1 | 63 | 15F241 | CAP, air, stud wall | 1 |
| 43 | 117661 | WISE, pin, dual reversible chucks | 1 | 64 | FTM979 | TIP, flat, stud wall | 1 |
| 52 | 15B817 | MANIFOLD, gun flush; round and flat pattern guns only | 1 | 10 | 15B801 | AIR CAP, for flat pattern guns, not included in Front End Replacement Kit 24636 | 1 |
| 53 | 117642 | NUT DRIVER, hex, 5/16 | 1 | 15D973 | AIR CAP, for spatter pattern gun, not included in Front End Replacement Kit 246361 | 1 | |
| 54 | 118575 | SCREWDRIVER, 1/8 blade | 1 | | | | |
| 58 | 15D972 | RETAINER, tip, spatter pattern gun only | 1 | | | | |
| 59 | 15D971 | TIP, spatter pattern gun only | 1 | | | | |
| 60 | 248019 | SEAL, package of 5, spatter pattern gun only. | 1 | | | | |
| 61 | 15F240 | ADAPTER, stud wall | 1 | | | | |

*Included in Spatter Tip Kit 248414.
Included in Stud Wall Foam Kit 249421.*

Mix Chamber Kits

Mix Chamber Part Reference Guide

Example part number AR4242:

| | | |
|---|-------------------------------|-------------------------------|
| AR | 42 | 42 |
| AR=Air purge round pattern AF=Air purge flat pattern | A orifice size (0.042 in.) | B orifice size (0.042 in.) |

Round Pattern

| Stainless Steel Mix Chamber Kit | Chromex Mix Chamber Kit | Nozzle Orifice Size | Nozzle Drill Bit Size, in. (mm) | Impingement Port Size | Impingement Port Drill Bit Size, in. (mm) | Counterbore Size | Counterbore Drill Bit Size, in. (mm) |
|---------------------------------|-------------------------|---------------------|---------------------------------|-----------------------|---|------------------|--------------------------------------|
| AR2020 | AR20CX | 0.042 | #58 (1.00) | 0.020 | #76 (0.50) | 0.060 | #53 (1.50) |
| AR2929 | AR29CX | 0.052 | #55 (1.30) | 0.029 | #69 (0.70) | 0.060 | #53 (1.50) |
| AR3737 | AR37CX | 0.052 | #55 (1.30) | 0.037 | #63 (0.94) | N/A | N/A |
| AR4242 | AR42CX | 0.060 | #53 (1.50) | 0.042 | #58 (1.00) | N/A | N/A |
| AR4747 | AR47CX | 0.0635 | 1/16 (1.59) | 0.0469 | #56 (1.18) | N/A | N/A |
| AR5252 | AR52CX | 0.070 | #50 (1.75) | 0.052 | #55 (1.30) | N/A | N/A |
| AR6060 | AR60CX | 0.086 | #44 (2.15) | 0.060 | #53 (1.50) | N/A | N/A |
| AR7070 | AR70CX | 0.094 | 3/32 (2.35) | 0.070 | #50 (1.75) | N/A | N/A |
| AR8686 | AR86CX | 0.116 | #32 (2.90) | 0.086 | #44 (2.15) | N/A | N/A |

Non 1:1 Ratio Round Mix Chamber Kits

| Mix Chamber Kit (includes drill bits) | Nozzle Orifice Size | Nozzle Drill Bit Size, in. (mm) | Impingement Port Size | Impingement Port Drill Bit Size, in. (mm) | Counterbore Size | Counterbore Drill Bit Size, in. (mm) |
|---------------------------------------|---------------------|---------------------------------|-----------------------|---|------------------|--------------------------------------|
| AR2232 | 0.094 | 0.047 (1.2) | 0.024 0.0325 | #74, 0.023 (0.57) #67, 0.032 (0.81) | 0.061 | #53, 0.0595 (1.5) |
| AR2942 | 0.053 | #55 (1.3) | 0.043 0.031 | #58, 0.042 (1.07) #69 0.029 (0.74) | 0.061 | #53, 0.0595 (1.5) |
| AR3729 | 0.053 | #55 (1.3) | 0.038 0.031 | #63, 0.037 (0.94) #69, 0.029 (0.74) | 0.061 | #53, 0.0595 (1.5) |

Flat Pattern

| Mix Chamber Kit (includes drill bits and o-ring) | Nozzle Orifice Size | Nozzle Drill Bit Size, in. (mm) | Impingement Port Size | Impingement Port Drill Bit Size, in. (mm) | Counterbore Size | Counterbore Drill Bit Size, in. (mm) |
|--|---------------------|---------------------------------|-----------------------|---|------------------|--------------------------------------|
| AF2020 | 0.094 | 3/32 (2.35) | 0.020 | #76 (0.50) | 0.060 | #53 (1.50) |
| AF2929 | 0.094 | 3/32 (2.35) | 0.029 | #69 (0.70) | 0.060 | #53 (1.50) |
| AF4242 | 0.094 | 3/32 (2.35) | 0.042 | #58 (1.00) | N/A | N/A |
| AF5252 | 0.094 | 3/32 (2.35) | 0.052 | #55 (1.30) | N/A | N/A |

| Non 1:1 Ratio Flat Mix Chamber Kits | | | | | | |
|---------------------------------------|---------------------|---------------------------------|-----------------------|---|------------------|--------------------------------------|
| Mix Chamber Kit (includes drill bits) | Nozzle Orifice Size | Nozzle Drill Bit Size, in. (mm) | Impingement Port Size | Impingement Port Drill Bit Size, in. (mm) | Counterbore Size | Counterbore Drill Bit Size, in. (mm) |
| AF2033 | 0.094 | 3/32 (2.35) | 0.035 0.021 | #66, 0.033 (0.84) #76 0.020 (0.51) | 0.061 | #53, 0.0595 (1.50) |
| AF2942 | 0.094 | 3/32 (2.35) | 0.042 0.031 | #58, 0.042 (1.07) #69 0.029 (0.74) | 0.061 | #53, 0.0595 (1.50) |

Wide Pattern

Kits include mix chamber and cleanout drills. Spray guns with wide pattern mix chambers spray larger diameter patterns than guns with the standard mix chambers.

| Kit | Pattern Diameter at 24 in. (609.6 mm) to target in. (mm) | Equivalent flow to mix chamber size | Nozzle Drill Bit Size in. (mm) | Impingement Drill Bit Size in. (mm) |
|--------|--|-------------------------------------|--------------------------------|-------------------------------------|
| AW2222 | 8 (203.2) | N/A | 0.047 (1.20) | #74, 0.022 (0.56) |
| AW2828 | 15 (381.0) | AR2929 | 1/16, 0.062 (1.59) | #70, 0.028 (0.71) |
| AW3333 | 15 (381.0) | AR3737 | #53, 0.060 (1.52) | #66, 0.033 (0.84) |
| AW3939 | 16 (406.4) | AR4242 | #50, 0.070 (1.78) | #61, 0.039 (0.99) |
| AW4646 | 18 (457.2) | AR5252 | 0.085 (2.15) | #56, 0.046 (1.17) |
| AW5757 | 18 (457.2) | AR6060 | #43, 0.089 (2.26) | 1.45 mm, 0.057 (1.45) |
| AW6464 | 22 (563.9) | AR7070 | 7/64, 0.109 (2.77) | #52, 0.064 (1.63) |
| AW8282 | 24 (609.6) | AR8686 | 1/8, 0.125 (3.18) | #45, 0.082 (2.08) |

Flat Tip Kits

Flat Tip Part Reference Guide

Example part number FT0848:

| FT | 08 | 48 |
|-------------|--------------------------------|--|
| FT=Flat tip | x2=pattern length (8x2=16 in.) | Equivalent orifice diameter size (0.048 in.) |

Flat Tip

| Flat Spray Tip (Ref. 39) | Pattern Size, in. (mm) |
|--------------------------|------------------------------|
| FT0424 | low flow, 8-10 (203-254) |
| FT0438 | medium flow, 8-10 (203-254) |
| FT0624 | low flow, 12-14 (305-356) |
| FT0638 | medium flow, 12-14 (305-356) |
| FT0838 | medium flow, 16-18 (406-457) |
| FT0848 | high flow, 16-18 (406-457) |

Gun Repair Kits

Read the chart left to right and top to bottom to find the quantity of each part in the kits.

| Ref. | Includes | | | | | |
|------|--|---------------------------------------|----------------------|-------------------------------|----------------------------|--|
| | Bulk O-ring Kits (quantity) | 246347 Side Seal Cartridge O-ring Kit | 246348 Side Seal Kit | 246351 Check Valve O-ring Kit | 246355 Complete O-ring Kit | 129209 High Temperature /Pressure O-ring Kit |
| 3 | 248137 (6) 25M244 (50) | | | | 1 | |
| 14 | 248136 (6) | | | | 1 | |
| 16 | 248135 (6) 25M245 (25) | | | | 1 | |
| 17 | 248134 (6) | | | | 1 | |
| 18c | ---- | | 2 | | | |
| 18d | 248130 (6) 25M242 (50) | 4 | | | 4 | |
| 18e | 248128 (6) 298790 (50) 25M221 (10) | 2 | 2 | | 2 | 2 |
| 21 | 248132 (6) | | | | 1 | |
| 23 | 248131 (6) 25M243 (50) | | | | 1 | |
| 24 | 246354 (6) 25M239 (50) | | | | 5 | |
| 26f | 248133 (6) | | | 2 | 2 | |
| 26g | 248129 (6) 25M247 (25) | | | 2 | 2 | |
| 40 | 246360 (3) 25M248 (25) | | | | | |

Check Valve Filter Screen Kits

Each kit includes ten filter screens.

The gun is shipped with 80 mesh filter screens.

| Part | Description |
|--------|---------------------------------|
| 246357 | 40 mesh (0.015 in., 375 micron) |
| 246358 | 60 mesh (0.010 in., 238 micron) |
| 246359 | 80 mesh (0.007 in., 175 micron) |

Drill Bit Kit

119386

Kit includes 20 cleanout drill bits ranging in sizes of #61 through #80.

Handle Cleanout Drill Kit

248969

Kit includes all 5 drill bits of extra long length needed to clean out the air passages in the Air Purge gun handle and fluid housing.

Drill Bit Kits





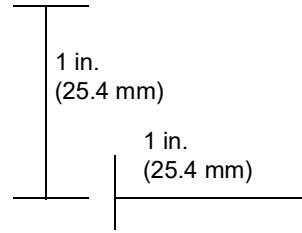







For cleaning gun ports and orifices. Illustrations are for diameter comparison. Actual length may vary.

NOTE: Not all sizes are used with your gun.







| Kit Part | Qty. | Drill Bit Size | | | Illustration |
|----------|------|----------------|-------|------|--------------|
| | | nominal | in. | mm | |
| 249115 | 6 | 1/8 | 0.125 | 3.18 | |
| 246623 | 3 | #32 | 0.116 | 2.90 | |
| 246810 | 3 | 7/64 | 0.109 | 2.77 | |
| 246813 | 3 | #39 | 0.099 | 2.51 | |
| 246624 | 3 | 3/32 | 0.094 | 2.39 | |
| 246812 | 3 | #43 | 0.089 | 2.26 | |
| 246625 | 3 | #44 | 0.086 | 2.18 | |
| 248639 | 6 | 2.15 mm | 0.085 | 2.15 | |
| 249114 | 6 | #45 | 0.082 | 2.08 | |
| 246811 | 3 | 2 mm | 0.079 | 2.00 | |
| 246626 | 6 | #50 | 0.070 | 1.78 | |
| 249113 | 6 | #52 | 0.64 | 1.63 | |
| 248893 | 6 | 1/16 | 0.062 | 1.59 | |
| 246627 | 6 | #53 | 0.060 | 1.52 | |
| 249112 | 6 | 1.45 mm | 0.057 | 1.45 | |
| 246809 | 6 | #54 | 0.055 | 1.40 | |
| 246628 | 6 | #55 | 0.052 | 1.32 | |
| 249764 | 6 | 1.20 mm | 0.047 | 1.20 | |
| 246814 | 6 | #56 | 0.046 | 1.18 | |
| 246629 | 6 | #58 | 0.042 | 1.07 | |

Parts

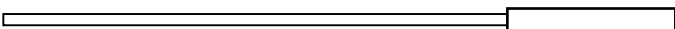
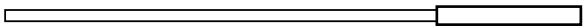
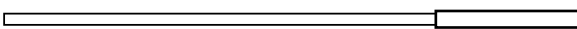
| Kit Part | Qty. | Drill Bit Size | | | Illustration |
|----------|------|----------------|-------|------|--|
| | | nominal | in. | mm | |
| 246808 | 6 | #60 | 0.040 | 1.02 |  |
| 248640 | 6 | #61 | 0.039 | 0.99 |  |
| 248618 | 6 | #63 | 0.037 | 0.94 |  |
| 248891 | 6 | #66 | 0.033 | 0.84 |  |
| 246807 | 6 | #67 | 0.032 | 0.81 |  |
| 246630 | 6 | #69 | 0.029 | 0.74 |  |
| 248892 | 6 | #70 | 0.028 | 0.71 |  |
| 246815 | 6 | #73 | 0.024 | 0.61 |  |
| 276984 | 6 | #74 | 0.023 | 0.57 |  |
| 246631 | 6 | #76 | 0.020 | 0.51 |  |
| 246816 | 6 | #77 | 0.018 | 0.46 |  |
| 246817 | 6 | #81 | 0.013 | 0.33 |  |

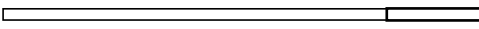
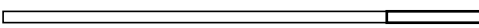
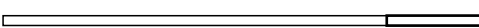
Reamer Kits

| Kit Part | Qty. | Reamer Size | | | Illustration |
|----------|------|-------------|-------|------|--|
| | | nominal | in. | mm | |
| 25B041 | 1 | #32 | 0.116 | 2.90 |  |
| 25B040 | 1 | 3/32 | 0.094 | 2.39 |  |
| 25B039 | 1 | #44 | 0.086 | 2.18 |  |
| 25B038 | 1 | #50 | 0.070 | 1.78 |  |
| 25B037 | 1 | 1/16 | 0.062 | 1.59 |  |
| 25B035 | 1 | #53 | 0.060 | 1.52 |  |
| 25B034 | 1 | #55 | 0.052 | 1.32 |  |
| 25B032 | 1 | #58 | 0.042 | 1.07 |  |

Accessories

Fusion PC Conversion Kits

For converting the Fusion AP spray gun to a Fusion PC spray gun for use with ProConnect™ fluid cartridges. See **Related Manuals**, page 3.

Round Pattern

| Conversion Kit | Mix Chamber | | | |
|----------------|-------------|-----------------------------------|-----------------|---|
| | Part Number | Impingement Port Size in. (mm) | Equivalent Size | Pattern at 24 in. (61 cm) from target in. (mm) |
| 25P700 | PC29RD | 0.029 (0.70) | 00 | 8 (203) |
| 25R087 | PC37RD | 0.037 (0.94) | 00-01 | 9 (227) |
| 25P701 | PC42RD | 0.042 (1) | 01 | 11 (279) |
| 25P703 | PC47RD | 0.0469 (1.18) | 01-02 | 11 (279) |
| 25P702 | PC52RD | 0.052 (1.3) | 02 | 12 (305) |
| 25R088 | PC60RD | 0.060 (1.50) | 03 | 14 (356) |

Flat Pattern

| Conversion Kit | Mix Chamber | | | Flat Tip | | |
|----------------|-------------|-----------------------------------|-----------------|-------------|--------------------------|--------------------------|
| | Part Number | Impingement Port Size in. (mm) | Equivalent Size | Part Number | Pattern Size in. (mm) | Orifice Size in. (mm) |
| 25R089 | AF2929 | 0.029 (0.70) | 00 | FT0438 | 8-10 (203-254) | 0.038 (0.97) |

Bare

NOTE: Bare conversion kits include the same accessories as standard conversion kits, without a mix chamber and drill bits. A round air cap is provided.

| Conversion Kit |
|----------------|
| 25P704 |

Side Seal Kits

Kits includes a packing o-ring for each seal.

| Material | Kit | Description | Qty. |
|-----------------|--------|-------------|------|
| Stainless Steel | 246348 | SEAL KIT | 2 |
| | 277299 | SEAL KIT | 50 |
| Polycarballoy | 249990 | SEAL KIT | 2 |
| | 277298 | SEAL KIT | 50 |
| Chromex | 25N573 | SEAL KIT | 2 |

Side Seal Cartridge Kits

| Material | Kit Part | Description | Qty. |
|-----------------|----------|-----------------------|------|
| Stainless Steel | 246349 | CARTRIDGE KIT, A side | 1 |
| | 246348 | CARTRIDGE KIT, B side | 1 |
| Polycarballoy | 277297 | CARTRIDGE KIT, A side | 1 |
| | 277296 | CARTRIDGE KIT, B side | 1 |
| Chromex | 25N571 | CARTRIDGE KIT, A side | 1 |
| | 25N752 | CARTRIDGE, B side | 1 |

Extension Tip Kits

Kits include extension, flat tip seal and round tip seal, cleanout drill bit, and instructions.

NOTE: Extension tip kits require 248020 Extension Tip Air Cap Kit (purchased separately).

| Kit | Hole Diameter x Length, in. (mm) | Recommended Mix Chambers | Spray Distance, ft (m) | Pattern Diameter, in. (mm) |
|--------|----------------------------------|--------------------------|------------------------|----------------------------|
| 248010 | 0.042 x 0.50 (1.06 x 12.7) | AR2020/AF2929 | 15 (4.57) | 10 (254) |
| 248011 | 0.052 x 0.50 (1.32 x 12.7) | AR2929/AF2929 | 12 (3.66) | 10 (254) |
| 248012 | 0.060 x 0.50 (1.52 x 12.7) | AR4242/AF4242 | 12 (3.66) | 12 (305) |
| 248013 | 0.070 x 0.50 (1.78 x 12.7) | AR5252/AF5252 | 8 (2.44) | 20 (508) |
| 248014 | 0.042 x 1.0 (1.06 x 25.4) | AR2020/AF2929 | 15 (4.57) | 10 (254) |
| 248015 | 0.052 x 1.0 (1.32 x 25.4) | AR2929/AF2929 | 12 (3.66) | 8 (203) |
| 248016 | 0.060 x 1.0 (1.52 x 25.4) | AR4242/AF4242 | 12 (3.66) | 8 (203) |
| 248017 | 0.070 x 1.0 (1.78 x 25.4) | AR5252/AF5252 | 8 (2.44) | 8 (203) |

* Measured with less than 8 in. (203 mm) drop in stream center at 1200 psi (8.4 MPa, 84 bar) static pressure.

Extension Tip Seal Kits

Kits include 5 seals.

| Kit Part | Description |
|----------|------------------------------|
| 248018 | Flat Extension Tip Seal Kit |
| 248019 | Round Extension Tip Seal Kit |

Extension Tip Air Cap Kit

248020

Includes air cap for use with extension tip kits 248010-248017.

Flat Pattern Stud Wall Kit

249421

To spray high-flow, flat patterns. For use with flat mix chambers only: AF2929, AF4242, AF5252. Includes adapter parts and cleanout tool. See **Related Manuals**, page 3.

NOTE: Flat pattern mix chamber not included. Order separately.

NOTE: Optional tip FTM762 available for lower flow and smaller pattern application

24C358

TP100 stud wall option to spray wall insulation foam into stud walls. See **Related Manuals**, page 3.

Pour Nozzle Kit

248528

To convert air purge gun for pour applications. Includes nozzle, seals, tubing, and cleanout drill bits.

Gun Cleaning Kit

15D546

Kit includes eleven tools and brushes to clean the gun.

Hose Adapter Kits

246944

To connect non-Graco gun to Graco heated hose.

248029

To connect Graco Fusion gun to non-Graco D-gun hose set.

246945

To connect Graco Fusion gun to non-Graco heated hose.

Spatter Conversion Kit

248414

To convert Fusion air purge gun to spray round pattern only, large droplet, low overspray applications. Includes air cap, tip, retainer, seal, and cleanout drill bits. See **Related Manuals**, page 3.

Gun Cover

244914

Keeps gun clean while spraying. Pack of 10.

Lubricant for Gun Rebuild

248279, 4 oz (113 gram) (Qty. 10)

High adhesion, water resistant, lithium-based lubricant. SDS available at www.graco.com

Grease Cartridge for Gun Shutdown

248280 Cartridge, 3 oz (Qty. 10)

Specially formulated low viscosity grease flows easily through gun passages, to prevent two component curing and keep fluid passages clean.

Flushing Manifold

15B817 Manifold Block

See Ref. 52.

Adjustable Flow Cap Kit

25D632

To allow variable flow to the Fusion AP gun. Refer to the Fusion Adjustable Flow Cap Kit manual. See **Related Manuals**, page 3.

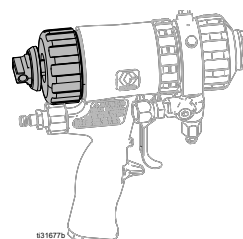

Solvent Flush Canister Kit

248139, 1 qt (0.95 l) Solvent Cup

Complete with 15B817 Flushing Manifold to flush gun with solvent. Portable for remote flushing. Refer to the Solvent Flush Kit manual. See **Related Manuals**, page 3.

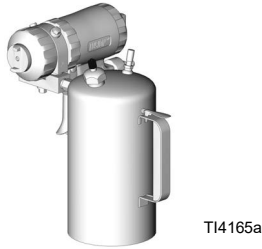

Solvent Flush Pail Kit

248229 5 gal. (19 l) Pail

Includes flush manifold with individual A and B shutoff valves, and air regulator. Refer to the Solvent Flush Kit manual. See **Related Manuals**, page 3.

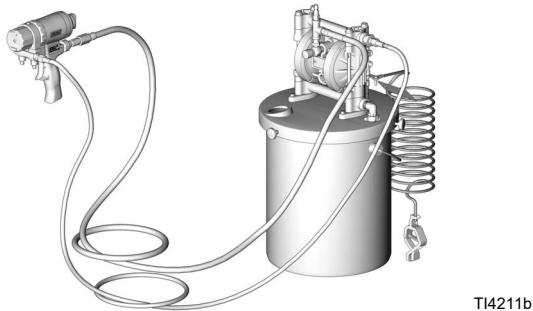

Tip Cleanout Tool

15D234

Designed to fit CeramTip internal dome and flat tip slits.

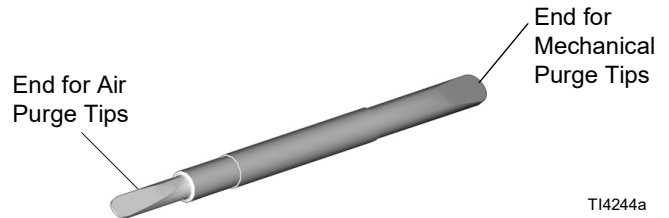

Circulation Manifold

246362

Attach to gun fluid manifold to enable preheating of hose. Refer to Circulation Manifold Kit Instruction Manual. See **Related Manuals**, page 3.

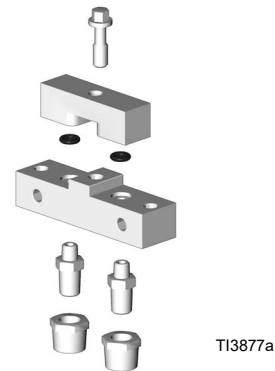

Technical Specifications

| Fusion Air Purge Spray Gun | | |
|--|--|-------------------|
| | US | Metric |
| Maximum Fluid Working Pressure | 3500 psi | 24.5 MPa, 245 bar |
| Minimum Air Inlet Pressure | 80 psi | 0.56 MPa, 5.6 bar |
| Maximum Air Inlet Pressure | 130 psi | 0.9 MPa, 9 bar |
| Air Flow Range | See chart below | |
| Typical Flow Rate of Round Pattern Guns | See Round Pattern Guns chart, page 4 | |
| Typical Flow Rate of Flat Pattern Guns | See Flat Pattern Guns chart, page 5 | |
| Maximum Fluid Temperature | 200° F | 94° C |
| Air Inlet Size | 1/4 npt Quick Disconnect Nipple | |
| A Component (ISO) Inlet Size | -5 JIC | 1/2-20 UNF |
| B Component (Resin) Inlet Size | -6 JIC | 9/16-18 UNF |
| Dimensions | 7.5 x 8.1 x 3.3 in. | 191 x 206 x 84 mm |
| Weight | 2.6 lb | 1.2 kg |
| Wetted Parts | Aluminum, stainless steel, carbon steel, carbide, chemically resistant o-rings | |
| Noise | | |
| Maximum sound pressure | 81.1 dB(A), using AR5252 at 100 psi (0.7 MPa, 7 bar) | |
| Maximum sound power | 91.0 dB(A), using AR5252 at 100 psi (0.7 MPa, 7 bar) | |
| <i>Sound power measured per ISO-9416-2.</i> | | |
| Notes | | |
| All trademarks or registered trademarks are the property of their respective owners. | | |

Air Flow by Mix Chamber

| Air Pressure (detriggered) psi (MPa, bar) | Mix Chamber Sizes (scfm (m ³ /min)) | | | | | | | |
|---|--|----------------|----------------|----------------|----------------|----------------|----------------|-----------------|
| | AR2020 | AR2929 | AR3737 | AR4242 | AR5252 | AR6060 | AR7070 | AR8686 |
| 80 (0.56, 5.6) | 0.8 (0.022) | 1.4 (0.039) | 2.0 (0.056) | 2.6 (0.073) | 3.7 (0.104) | 4.6 (0.129) | 5.7 (0.160) | 7.1 (0.200) |
| 100 (0.7, 7) | 0.9 (0.025) | 1.7 (0.048) | 2.9 (0.081) | 3.1 (0.087) | 4.6 (0.129) | 5.7 (0.160) | 7.1 (0.200) | 8.8 (0.246) |
| 130 (0.9, 9) | 1.2 (0.034) | 2.3 (0.064) | 3.2 (0.090) | 4.1 (0.115) | 5.9 (0.165) | 7.3 (0.204) | 9.2 (0.258) | 11.3 (0.316) |

Graco Standard Warranty

Graco warrants all equipment referenced in this document which is manufactured by Graco and bearing its name to be free from defects in material and workmanship on the date of sale to the original purchaser for use. With the exception of any special, extended, or limited warranty published by Graco, Graco will, for a period of twelve months from the date of sale, repair or replace any part of the equipment determined by Graco to be defective. This warranty applies only when the equipment is installed, operated and maintained in accordance with Graco's written recommendations.

This warranty does not cover, and Graco shall not be liable for general wear and tear, or any malfunction, damage or wear caused by faulty installation, misapplication, abrasion, corrosion, inadequate or improper maintenance, negligence, accident, tampering, or substitution of non-Graco component parts. Nor shall Graco be liable for malfunction, damage or wear caused by the incompatibility of Graco equipment with structures, accessories, equipment or materials not supplied by Graco, or the improper design, manufacture, installation, operation or maintenance of structures, accessories, equipment or materials not supplied by Graco.

This warranty is conditioned upon the prepaid return of the equipment claimed to be defective to an authorized Graco distributor for verification of the claimed defect. If the claimed defect is verified, Graco will repair or replace free of charge any defective parts. The equipment will be returned to the original purchaser transportation prepaid. If inspection of the equipment does not disclose any defect in material or workmanship, repairs will be made at a reasonable charge, which charges may include the costs of parts, labor, and transportation.

THIS WARRANTY IS EXCLUSIVE, AND IS IN LIEU OF ANY OTHER WARRANTIES, EXPRESS OR IMPLIED, INCLUDING BUT NOT LIMITED TO WARRANTY OF MERCHANTABILITY OR WARRANTY OF FITNESS FOR A PARTICULAR PURPOSE.

Graco's sole obligation and buyer's sole remedy for any breach of warranty shall be as set forth above. The buyer agrees that no other remedy (including, but not limited to, incidental or consequential damages for lost profits, lost sales, injury to person or property, or any other incidental or consequential loss) shall be available. Any action for breach of warranty must be brought within two (2) years of the date of sale.

GRACO MAKES NO WARRANTY, AND DISCLAIMS ALL IMPLIED WARRANTIES OF MERCHANTABILITY AND FITNESS FOR A PARTICULAR PURPOSE, IN CONNECTION WITH ACCESSORIES, EQUIPMENT, MATERIALS OR COMPONENTS SOLD BUT NOT MANUFACTURED BY GRACO. These items sold, but not manufactured by Graco (such as electric motors, switches, hose, etc.), are subject to the warranty, if any, of their manufacturer. Graco will provide purchaser with reasonable assistance in making any claim for breach of these warranties.

In no event will Graco be liable for indirect, incidental, special or consequential damages resulting from Graco supplying equipment hereunder, or the furnishing, performance, or use of any products or other goods sold hereto, whether due to a breach of contract, breach of warranty, the negligence of Graco, or otherwise.

FOR GRACO CANADA CUSTOMERS

The Parties acknowledge that they have required that the present document, as well as all documents, notices and legal proceedings entered into, given or instituted pursuant hereto or relating directly or indirectly hereto, be drawn up in English. Les parties reconnaissent avoir convenu que la rédaction du présente document sera en Anglais, ainsi que tous documents, avis et procédures judiciaires exécutés, donnés ou intentés, à la suite de ou en rapport, directement ou indirectement, avec les procédures concernées.

Graco Information

For the latest information about Graco products, visit www.graco.com.

For patent information, see www.graco.com/patents.

TO PLACE AN ORDER, contact your Graco distributor or call to identify the nearest distributor.

Phone: 612-623-6921 **or Toll Free:** 1-800-328-0211, **Fax:** 612-378-3505

All written and visual data contained in this document reflects the latest product information available at the time of publication. Graco reserves the right to make changes at any time without notice.

Original instructions. This manual contains English. MM 309550

Graco Headquarters: Minneapolis

International Offices: Belgium, China, Japan, Korea

GRACO INC. AND SUBSIDIARIES • P.O. BOX 1441 • MINNEAPOLIS MN 55440-1441 • USA
Copyright 2020, Graco Inc. All Graco manufacturing locations are registered to ISO 9001.

www.graco.com
Revision ZAS, July 2022